

applications & TOOLS

**IWLAN Configuration Using RCoax
in a PROFINET IO Environment**

SIEMENS

Configuration 6



Configuration 6

Entry ID: 23488061

Note

The Application Examples are not binding and do not claim to be complete regarding the circuits shown, equipping and any eventuality. The Application Examples do not represent customer-specific solutions. They are only intended to provide support for typical applications. You are responsible for ensuring that the described products are correctly used. These Application Examples do not relieve you of the responsibility of safely and professionally using, installing, operating and servicing equipment. In using these Application Examples, you recognize that Siemens cannot be made liable for any damage/claims beyond the liability clause described. We reserve the right to make changes to these Application Examples at any time without prior notice. If there are any deviations between the recommendations provided in these application examples and other Siemens publications – e.g. Catalogs – the contents of the other documents have priority.

Warranty, liability and support

We accept no liability for information contained in this document.

Any claims against us - based on whatever legal reason - resulting from the use of the examples, information, programs, engineering and performance data etc., described in this application example shall be excluded. Such an exclusion shall not apply in the case of mandatory liability, e.g. under the German Product Liability Act (Produkthaftungsgesetz), in case of intent, gross negligence, or injury of life, body or health, guarantee for the quality of a product, fraudulent concealment of a deficiency or breach of a condition which goes to the root of the contract (Wesentliche Vertragspflichten). However, claims arising from a breach of a condition which goes to the root of the contract shall be limited to the foreseeable damage which is intrinsic to the contract, unless caused by intent or gross negligence or based on mandatory liability for injury of life, body or health. The above provisions do not imply a change in the burden of proof to your detriment.

Copyright© 2009 Siemens A&D. It is not permissible to transfer or copy these Application Examples or excerpts of them without first having prior authorization from Siemens A&D in writing.

For questions about this document please use the following e-mail address:

<mailto:csweb@ad.siemens.de>

Configuration 6

Entry ID: 23488061

Foreword

Configurations are fully functional and tested automation configurations based on A&D standard products for simple, fast and inexpensive implementation of automation tasks. Each of the available Configurations covers a frequently occurring subtask of a typical customer problem.

The configurations help the customer to obtain answers with regard to required products and how they function in combination. A tested example application is provided for this.

However, depending on the requirements of the system, a variety of other components (e.g., other CPUs, power supplies, etc.) can be used to implement the functionality on which this configuration is based. Please refer to the respective SIEMENS A&D catalogs for these components.

Configuration 6

Entry ID: 23488061

Table of Contents

1	Application Areas and Benefit	5
2	Configuration.....	9
3	Required Hardware and Software Components.....	10
4	Function Principle of IWLAN and Rapid Roaming.....	13
5	Configuring and Commissioning the Example Project	15
5.1	Hardware configuration	16
5.2	Parameterization.....	18
5.3	Configuration of modules	19
5.3.1	Assigning IP address and device names.....	19
5.3.2	Parameterizing an access point.....	24
5.4	Loading the SIMATIC station and testing the S7 functionality.....	31
5.5	Function test	35
5.6	Update time in PN IO systems	40
6	Technical Data.....	44
7	Important Terms and Bibliographic References	48

1 Application Areas and Benefit

Introduction

Modern automation technology is based on communication and an increasing networking of individual islands of production. At the same time, the integration of all production components with a consistent networking to the office network or the company intranet is becoming more and more important.

Movable stations can be integrated cost-effectively and flexibly via IWLAN. Connections via slip rings etc. being difficult to maintain and interference-prone are not required.

The PROFINET IO via IWLAN with RCOAX leaky wave cable offers the vertical integration of mobile stations even in an interference-prone environment.

Figure 1



Monorail conveyor as an example for the IWLAN/RCOAX application

Configuration 6

Entry ID: 23488061

Automation task

A solution based on a conventional bus technology is to be extended and modernized:

Replacing an existent PROFIBUS connection via slip rings to a moving work station by PROFINET IWLAN

Integrating PROFIBUS slaves into the PROFINET IWLAN concept

Integrating a PROFINET device via IWLAN

The general precondition is keeping the real-time requirements (RT) of the IWLAN system being customary for distributed I/O despite unfavorable radio environment (update time of 16 milliseconds or more).

SIEMENS

Application Areas and Benefit

Configuration 6

Entry ID: 23488061

Automation solution – Configuration 6

This configuration shows how to employ and parameterize the PROFINET components.

Supplementing the central controller by the PROFINET communications processor CP343-1

Setting up the infrastructure with SCALANCE PROFINET components

Using RCoax antennas (two segments)

Connecting ET200S with IM151 PROFIBUS via IWLAN/PB Link PN IO

Connecting ET200S with IM151 PROFINET via ClientModule W747-1RR

Using rapid roaming / iPCF

Automation scenario:

- Setting an output in the ET200 station,
- Reading via an input
- Monitoring the update time

Figure 2

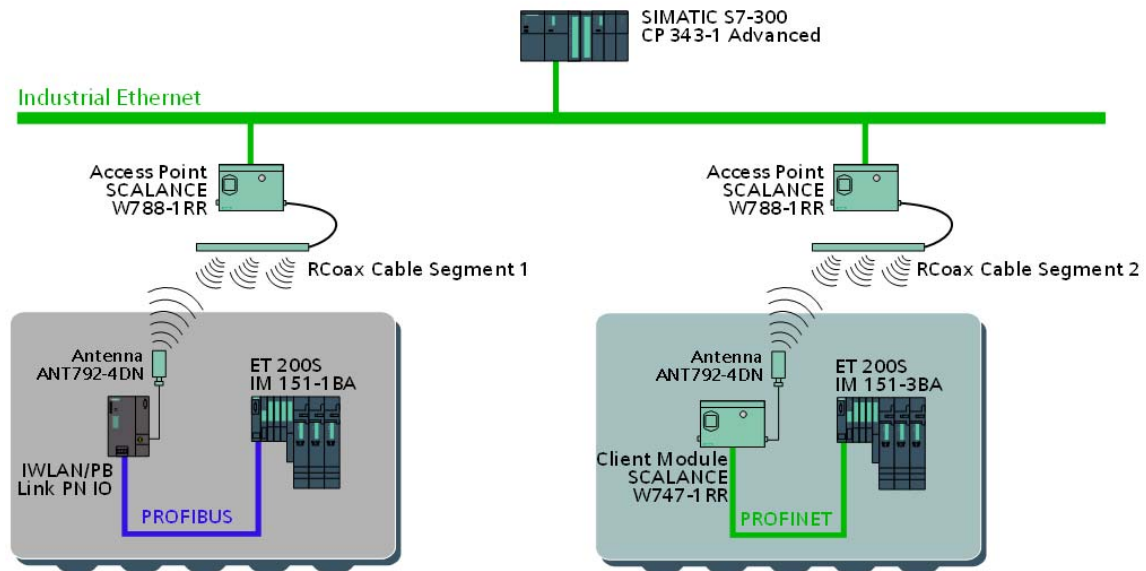

Configuration 6

Entry ID: 23488061

Application areas

The IWLAN products of SIMATIC NET are particularly designed for being used in production plants. The RCoax cable can show its advantages particularly in case of mobile stations moving along a given distance within environments demanding with regard to radio. Along the cable, a defined and limited radio field is formed, exactly running where needed. Even around corners and in narrow passage ways. The RCoax cable can be connected to all SCALANCE W-700 Access Points.

Benefits

Robust design suitable for industrial use

Reaction-free integration into existing network topology is possible

Very simple and user-friendly configuration and administration without any special IT knowledge

Maximum reliability due to a controlled and defined radio field

Contact-free data transfer, thus wear-free and requiring little maintenance

Flexible application options

Cost saving due to substitution of contact conductors and trailing cables

Investment protection by integrating PROFIBUS devices via IWLAN/ PB Link PN IO

PROFINET I/O communication without interruption when roaming

2 Configuration

The figure below shows the realized hardware setup of this configuration.

Figure 3

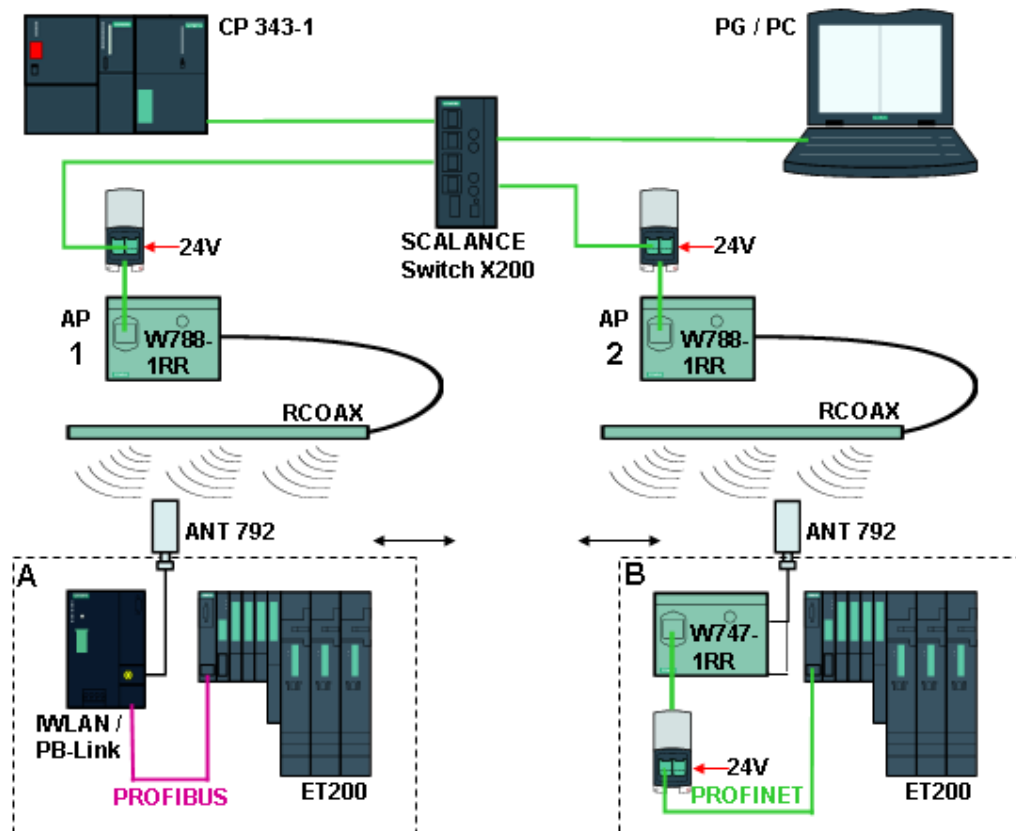

Copyright © Siemens AG 2009 All rights reserved
23488061_IWLAN_RCOAX_DOKU_V11_e.doc

A central CPU-2DP is completed by the CP343-1 for the PROFINET communication. This is connected to the PG and the two AccessPoints SCALANCE W788-1RR via a SCALANCE Switch X20x. The antennas are two leaky wave RCOAX cables with the appropriate connection elements and terminating resistors.

Each of the two distributed and mobile automation cells contain a SIMATIC S7-ET200S station:

Cell A an IWLAN/PB link PNIO with subordinate PROFIBUS network;

Cell B a SCALANCE W747 client with PROFINET network

Note

The power supply (DC 24 V) of the SIMATIC station is used in this test setup also for supplying the other modules.

Configuration 6

Entry ID: 23488061

3 Required Hardware and Software Components

The hardware components specified here are the minimum requirements. You can easily select components with a larger range of functions, only the HW Config and the cfg files are to be adjusted accordingly. Depending on the radio environment, it would be advisable to use the 5GHz band instead of the 2.4GHz band. However, then you have to order all related, frequency-dependent components and cables.

Note Please bear in mind to install the latest HW updates for Step. For further information please cf. Step7 help.

IWLAN components SIMATIC NET

Table 1

Component	Type	MLFB / Order Number	No.	Note
Switch	SCALANCE X204-2	6GK5204-2BB00-2AA3	1	4 X RJ45
Access point	SCALANCE W788-1RR	6GK5788-1SR00-2AA6	2	RAPID ROAMING
Client module	SCALANCE W747-1RR	6GK5747-1SR00-2AA6	1	RAPID ROAMING
IWLAN/PB-Link	IWLAN/PB LINK PN IO	6GK1417-5AB00	1	RAPID ROAMING
Leaky wave cable	RCOAX CABLE 2.4GHZ	6XV1875-2A	1	MINIMUM ORDER QUANTITY 20M
Connector RCOAX	RCOAX N-CONNECT FEMALE 2.4 GHZ	6GK5798-0CN00-0AA0	4	FIELD MANUFACTURABILITY
Terminating resistance RCOAX	RCOAX N-CONNECT TERMINATION 2.4GHZ	6GK5795-1TN00-1AA0	2	
Connection	RCOAX N-CONNECT/ R-SMA, 2.4GHZ	6XV1875-5CH10	4	LENGTH 1M
Terminating resistance W7xx	TERMINATION IMPEDANCE F. 2. ANTENNA SOCKETS	6GK5795-1TR00-0AA6	1	3 PIECES
Helix antenna	RCOAX ANTENNA 2.4GHZ	6GK5792-4DN00-0AA6	2	
Connection module	MODULAR OUTLET WITH POWER INSERT	6GK1901-1BE00-0AA3	3	1 X 24 V DC AND 1 X 100 MBIT/S
Connection IE&24V	IE HYBRID CABLE 2X2 + 4X0,34	6XV1870-2J	1	MINIMUM ORDER QUANTITY 20M

SIEMENS

Required Hardware and Software Components

Configuration 6

Entry ID: 23488061

Component	Type	MLFB / Order Number	No.	Note
Connection IE	IE FC TP STANDARD CABLE, 2X2	6XV1840-2AH10	1	MINIMUM ORDER QUANTITY 20M
Plug-in connector	IE FC RJ45 PLUG 180°	6GK1901-1BB10-2AA0	6	FIELD MANU- FACTURABILITY
Plug-in connector	IE FC RJ45 PLUG 90°	6GK1901-1BB20-2AA0 6GK1901-1BB20-2AB0	12	1 PIECE 10 PIECES FIELD MANU- FACTURABILITY
Tool	RCOAX N-CONNECT STRIPPING TOOL	6GK1901-1PH00	1	FOR STRIPPING THE INSULATION FROM THE RCOAX CABLE IN THE FIELD

SIEMENS

Required Hardware and Software Components

Configuration 6

Entry ID: 23488061

SIMATIC hardware and software

Table 2

Component	Type	MLFB / Order Number	No.	Note
PG	Field PG	6ES7711-	1	Field PG Configurator
STEP 7 version 5.3		6ES7 810-4CC07-0YA5	1	
SP3 for STEP 7 V5.3 (or higher)			1	Download: 21953245
SIMATIC station				
Power supply	PS 307 5A	6ES7 307-1EA00-0AA0	1	
S7-300 CPU	CPU 315-2 DP	6ES7315-2AG10-0AB0	1	
S7-300 CP	CP 343-1	6GK7343-1EX21-0XE0	1	
ET 200S PNIO				
	Interface module IM 151-1 PB	6ES7 151-1BA01-0AB0	1	Cell A
	Interface module IM 151-3 PN	6ES7 151-3BA20-0AB0	1	Cell B
	Power module PM-E DC 24V	6ES7 138-4CA01-0AA0	2	
	Digital output module 2 DO DC 24V	6ES7 132-4BB01-0AB0	2	5 pcs.
	Digital input module 4 DI DC 24V	6ES7131-4BD01-0AB0	2	5 pcs.
	Terminal module TM-P	6ES7 193-4CD20-0AA0	1	
	Terminal module TM-E	6ES7 193-4CA40-0AA0	1	5 pcs.
Accessories				
Micro Memory Card	2 MB	6ES7 953-8LL11-0AA0	2	
PROFIBUS connector	Cable outlet 90°, PG-SST	6ES7972-0BB50-0XA0	2	
PROFIBUS line	PB FC STANDARD, 2-WIRE	6XV1830-0EH10	1	MINIMUM ORDER QUANTITY 20M

 Copyright © Siemens AG 2009 All rights reserved
 23488061_IWLAN_RCOAX_DOKU_V11_e.doc

4 Function Principle of IWLAN and Rapid Roaming

Industrial Ethernet (in the past: SINEC H1) is a setup technology allowing for an interference-free transfer of data in an industrial environment. The openness of PROFINET enables you to use standard Ethernet components. However, we recommend to setup PROFINET as an Industrial Ethernet.

If the entire network, or parts of it, consists of radio connections, this is referred to as a radio network or Wireless LAN. Apart from the data communication according to the Standard IEEE 802.1, the Industrial Wireless LAN IWLAN of SIMATIC NET also offers a multitude of extensions (I-features) being very useful for the industrial customer. IWLAN is particularly suitable for demanding industrial applications requiring a reliable radio communication.

Network architecture

In case of Wireless LAN network you differentiate between two network types:

Ad hoc network

Direct connection between stations, the simplest case of a Wireless LAN network according to IEEE 802.11. These networks are used for a temporary exchange of data over small distances.

Infrastructure mode

In the infrastructure mode, the communication takes place via the access point. In the simplest case, there is a group of IEEE 802.11 stations in the radio area of this access point. That kind of network is called Basic Service Set (BSS).

If the radio area of an access point is insufficient because of an inadequate range or because there are not enough stations operable, then two or more overlapping BSS can be operated in a common network (Extended Service Set, ESS). In that case, the access points are to be linked via a network behind, which can either be wire-bound (e.g. Ethernet), or which can be implemented by means of directional radio distances (Wireless Distribution System, WDS). In this operating mode, other stations outside the direct range of an access point can communicate even if they are in the area of another one. In the ESS mode, not only the localization of the stations in the respective BSS is controlled, but also the change of a station from one access point to another one (Roaming). In the infrastructure mode, the stations have to register at the access point and they transfer on the channel determined by it. The infrastructure operation enables the setup of large networks and particularly supports the operation within an Ethernet network. Wireless LAN according to IEEE 802.11 is also referred to as Wireless Ethernet.

Rapid roaming

Roaming is the free movement of Wireless LAN stations even beyond the limits of the radio cell of an access point. When connecting two or more access points via an Ethernet and setting the same radio network name (SSID) on all access points, you will extend the range of the radio network. The clients will automatically be transferred between the access points (roaming), as soon as the location of the client changes accordingly. Without any noticeable interruption, the station can change from one radio cell to the next one.

In case of industrial applications, it is important to perform this change particularly quickly to avoid an interruption of communication and to keep the update times. Especially when using the iPCF settings, the short roaming time is kept for the PROFINET IO. For movable stations, the transfer is made from an SCALANCE W788-1RR access point to the next one with Rapid Roaming (RR) so fast that even the PROFINET I/O communication is possible without losing messages. This is supported by the definition, which is more precise compared to the "classical" radio fields, and by the increased reliability of the radio field due to the RCoax cable.

Please see also /11/ "IWLAN: Setup of a Wireless LAN in the Industrial Environment"

5 Configuring and Commissioning the Example Project

Preliminary remark

As startup we offer you a completed STEP 7 example project and the appropriate configuration files for the IWLAN components for downloading. This software example supports you in the first steps and tests with this configuration. It enables a quick function test of hardware and software interfaces between the products described here.

The software example is always assigned to the components used in this configuration and shows their principal interaction. However, it is not a real application in the sense of technological problem solving with definable properties.

The following chapters take you step by step through the configuration.

Note

Please bear in mind to install the latest HW updates for Step. For further information please cf. Step7 help.

Download

The STEP 7 example project and the cfg files are available on the HTML page from which you downloaded this document. Upon downloading, extract the zip-file with any unzip-program, like, e.g. Winzip, and store the files on the hard disk and retrieve the STEP 7 project by means of the STEP 7 software.

Table 3

File	Contents
23488061_RCoax_Code_V10.zip	All files on this configuration, consisting of:
Step7_RCOAX.zip	Step7 project, retrieving with Step 7
cfgFile-W788-1_IWLAN-LINK-CONFIG.cfg	Configuration file for an access point W788-1RR for initial commissioning the IWLAN-PB-Link PNIO
cfgFile-W788-1.cfg	Configuration of access point 1
cfgFile-W788-2.cfg	Configuration of access point 2
cfgFile-W747.cfg	Configuration of the client module
config.cfg	Configuration of the IWLAN/PB-Link PN IO

5.1 Hardware configuration

Table 4

No.	Action	Remark/figure
1.	Preparing the RCOAX leaky wave cable	<ul style="list-style-type: none"> • Cut off two pieces (at least 1m) from the roll with a hacksaw • Mount the connectors by means of the stripping tools. • Absolutely comply with the notes in the System Manual RCOAX /1/ on pages 21 – 24.
2.	Installing SCALANCE W788 and W747	<ul style="list-style-type: none"> • You can supply the SCALANCE W788 and W747 modules via the hybrid plug X1 simultaneously with voltage (24VDC) and data (RJ45 Port). The hybrid plug is contained in the delivery scope; please note the enclosed assembly instruction. • Data and energy are fed via the connection module “MODULAR OUTLET WITH POWER INSERT” and the hybrid cable. An assembly instruction is included. • If you connect the modules via the optional, redundant power supply X2, you can also use an RJ45 patch cable for the LAN connection. Please observe the notes for the degree of protection. • Operating instructions SCALANCE W78x /2/ on pages 31 – 37 • Operating instructions SCALANCE W74x /3/ on pages 25 -31 • Assembly instructions for Modular Outlet with Power Insert /4/
3.	Installing IWLAN/PB-Link	<ul style="list-style-type: none"> • The network transition is connected to the helix antenna via a connection line. • The ET200S is connected to the PROFIBUS interface. • Manual IWLAN/PB Link PN IO /5/

SIEMENS

Configuring and Commissioning the Example Project

Configuration 6

Entry ID: 23488061

No.	Action	Remark/figure
4.	Overview of the assembly of other parts like antennas and terminating resistors for SCALANCE W788 and W747	
5.	Overview of the assembly of other parts like antennas and terminating resistors for SCALANCE W788 and IWLAN/PB-Link PN IO	
6.	Communications processor CP343-1	Please observe the operating instruction "S7-CPs for Industrial Ethernet Configuring and Commissioning" /6/ when installing.
7.	ET200S	<ul style="list-style-type: none"> The general information for Distributed I/O ET 200S is available in Operating Instruction /7/ Mount the terminal module, the modules and the bus terminating element (delivery scope IM151). Station A "PROFIBUS" DIP switch is to be set to DP-address "8" Station B "PROFINET" Plug a MicroMemoryCard MMC into the appropriate pick-up slot. Place the helix antennas near the leaky wave cables, which, however, may not be placed too near to each other. You can optimize the antenna alignment later on with the diagnostic function
8.	You can now start the station.	

Copyright © Siemens AG 2009 All rights reserved
 23488061_IWLAN_RCOAX_DOKU_V11_e.doc

5.2 Parameterization

The following table contains an overview of all IP addresses used in this example.

If you use a PG with LAN and WLAN adapter, assign different IP addresses to these two interfaces. Switch off the WLAN interface for the time being.

Table 5

Component	IP address	Device name
Switch	192.168.0.99	SCALANCE-X204
CP343	192.168.0.100	CP-343-1
W788 1	192.168.0.101	SCALANCE-W788RR-1
W788 2	192.168.0.102	SCALANCE-W788RR-2
W747	192.168.0.103	SCALANCE-W747RR
IM151-3	192.168.0.104	IM151-3PNHF
PB-Link	192.168.0.105	IWLAN-PB-Link
PG-WLAN	192.168.0.210	
PG-LAN	192.168.0.211	

Subnet mask 255.255.255.0

Assigning the IP address of the PG

Table 6

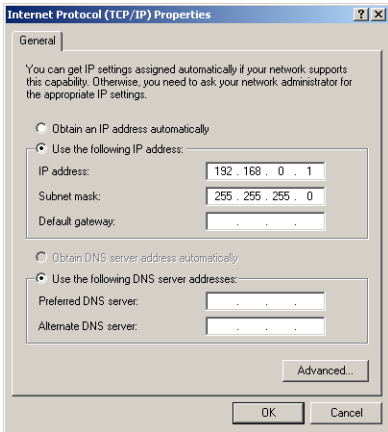
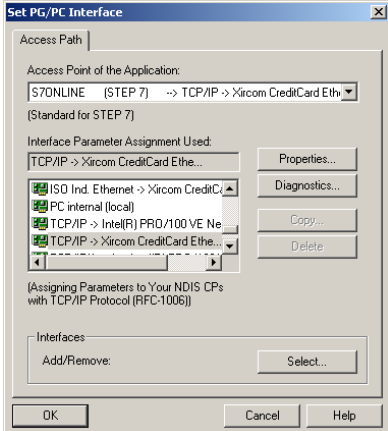
No.	Action	Remark/figure
1.	Select the option field "Use the following IP address" and enter the IP address and subnet mask of the PG according to table 5. Terminate the dialogs with "OK".	
2.	Finally you set the access path with the PG/PC interface to the used Ethernet CP and TCP/IP.	
3.	If your PG has an IWLAN interface, switch this off.	Of course you can work via the IWLAN, if all the IWLAN components are configured

 Copyright © Siemens AG 2009 All rights reserved
 23488061_IWLAN_RCOAX_DOKU_V11_e.doc

5.3 Configuration of modules

5.3.1 Assigning IP address and device names

The IP addresses or device names of the network nodes are to be assigned before being used, as all modules will be addressed via these addresses or names in future.

In the first step you can only access the devices, which are connected to the PG via the patch cable, in the central node: CP, switch, AP1 and AP2.

The IWLAN/PB-Link PN IO can only be reached with special settings via an access point, see the following chapter.

SIEMENS

Configuring and Commissioning the Example Project

Configuration 6

Entry ID: 23488061

You come to the client module SCALANCE W747 and the head station IM151-3 PN when connecting the patch cable of the PG to the 2nd interface of the IM151.

Table 7

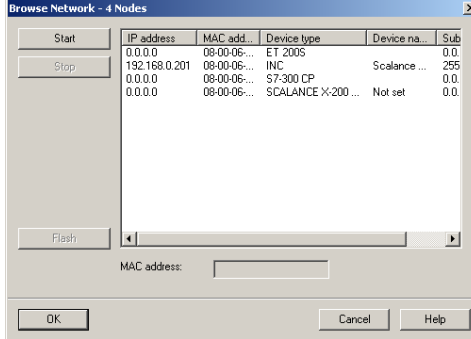
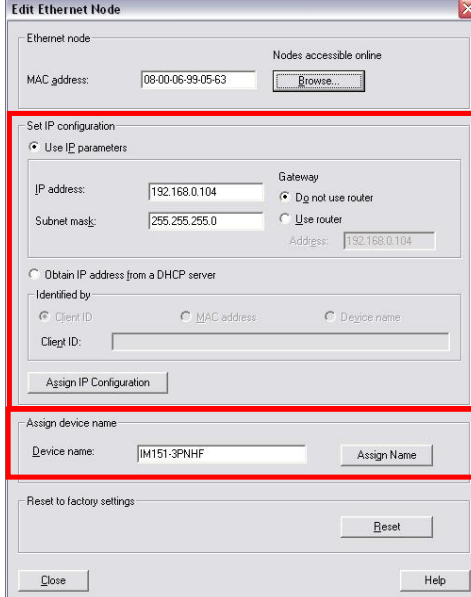
No.	Action	Remark/figure
1.	<p>Start the SIMATIC Manager. Select: PLC ► Edit Ethernet node ► Browse</p> <p>You can see a list of internal network nodes. In the delivery status, they only have an MAC address (see glossary) and no valid IP address yet. If the devices have already been used, you can enter any address and name. You can clearly identify the component via the MAC address, which has been assigned in the factory and printed on the outside of the casing. By means of the “Blinking” function you can quickly find the component in larger constructions. Select the line and click “OK”.</p>	
2.	<p>Assigning device names Enter the name also used for the STEP7-configuration into the “Device name” window. Click “Assign device name”.</p> <p>Assigning the IP configuration Enter the IP address and the subnet mask of the module according to table 5. The click “Assign IP Configuration”.</p>	
3.	<p>In the same way, you assign the names and addresses for the other modules.</p>	

Copyright © Siemens AG 2009 All rights reserved
23488061_IWLAN_RCOAX_DOKU_V11_e.doc

SIEMENS

Configuring and Commissioning the Example Project

Configuration 6

Entry ID: 23488061

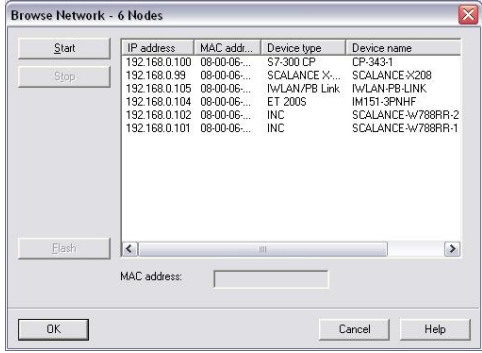
No.	Action	Remark/figure																																			
4.	Upon a new "network scan" (see step 1) you will see the figure on the right.	 <table border="1"> <caption>Browse Network - 6 Nodes</caption> <thead> <tr> <th>Start</th> <th>IP address</th> <th>MAC addr...</th> <th>Device type</th> <th>Device name</th> </tr> </thead> <tbody> <tr> <td>Stop</td> <td>192.168.0.100</td> <td>08-00-06-...</td> <td>S7-300 CP</td> <td>CP-343-1</td> </tr> <tr> <td></td> <td>192.168.0.99</td> <td>08-00-06-...</td> <td>SCALANCE X...</td> <td>SCALANCE-X208</td> </tr> <tr> <td></td> <td>192.168.0.105</td> <td>08-00-06-...</td> <td>IWLAN/PB Link</td> <td>IWLAN-PB-LINK</td> </tr> <tr> <td></td> <td>192.168.0.104</td> <td>08-00-06-...</td> <td>ET 200S</td> <td>IM151-3PNHF</td> </tr> <tr> <td></td> <td>192.168.0.102</td> <td>08-00-06-...</td> <td>INC</td> <td>SCALANCE-W788RR-2</td> </tr> <tr> <td></td> <td>192.168.0.101</td> <td>08-00-06-...</td> <td>INC</td> <td>SCALANCE-W788RR-1</td> </tr> </tbody> </table>	Start	IP address	MAC addr...	Device type	Device name	Stop	192.168.0.100	08-00-06-...	S7-300 CP	CP-343-1		192.168.0.99	08-00-06-...	SCALANCE X...	SCALANCE-X208		192.168.0.105	08-00-06-...	IWLAN/PB Link	IWLAN-PB-LINK		192.168.0.104	08-00-06-...	ET 200S	IM151-3PNHF		192.168.0.102	08-00-06-...	INC	SCALANCE-W788RR-2		192.168.0.101	08-00-06-...	INC	SCALANCE-W788RR-1
Start	IP address	MAC addr...	Device type	Device name																																	
Stop	192.168.0.100	08-00-06-...	S7-300 CP	CP-343-1																																	
	192.168.0.99	08-00-06-...	SCALANCE X...	SCALANCE-X208																																	
	192.168.0.105	08-00-06-...	IWLAN/PB Link	IWLAN-PB-LINK																																	
	192.168.0.104	08-00-06-...	ET 200S	IM151-3PNHF																																	
	192.168.0.102	08-00-06-...	INC	SCALANCE-W788RR-2																																	
	192.168.0.101	08-00-06-...	INC	SCALANCE-W788RR-1																																	

Note
HW Config of the STEP 7 project

The STEP 7 project contains the **ET200S**, so-called **PROFINET IO devices**. They are configured in a way that you only need to assign one device name to them. The IP address is then assigned by the **PROFINET IO controller (CP 343-1GX21)**.

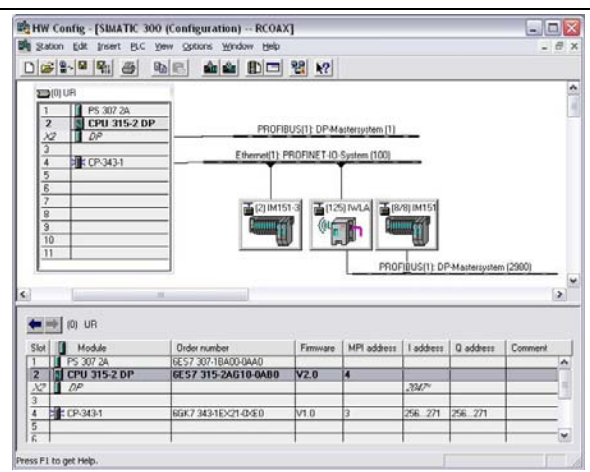

Note
Primary Setup Tool PST

IP addresses and device names can be configured without Step 7. You will find the PST on the "SIMATIC NET IWLAN System Software" CD.

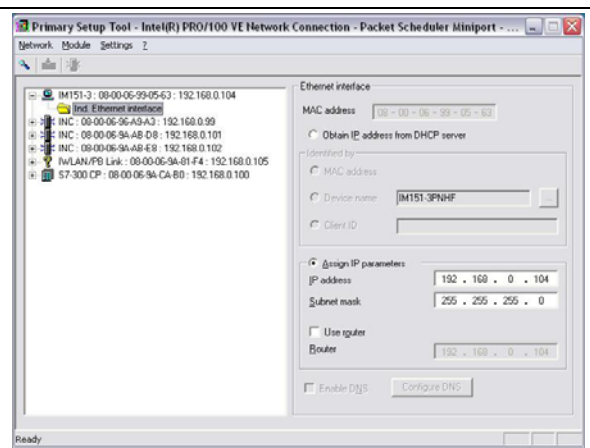

Copyright © Siemens AG 2009 All rights reserved
 23488061_IWLAN_RCOAX_DOKU_V11_e.doc

Parameterizing the IWLAN/PB-Link

In this case, the link is parameterized and operated via the CommandLineInterface CLI. This can only be done via the IWLAN interface. In the delivery status, the factory settings are to be parameterized on an assigned access point to enable their connection to the IWLAN/PB-Link.

Note

In the delivery status, the IWLAN/PB Link PN IO is configured in a way that it is connected to the following settings after the start with an AP (access point):

- SSID "WLAN_CONFIG_AP"
- 802.11g mode
- Country code: Germany
- Open System (Security)
- Without iPCF

A file with the same configuration is added to the example program. The chapter "Saving and loading the configuration file" describes how you can load the "cfgFile-W788-1_IWLAN-LINK-CONFIG.cfg" configuration to access point 1.

It is absolutely necessary to observe the manual "Network transitions IWLAN/PB Link PN IO for Industrial Ethernet, Part BL2" /8/ Page 19 –20, 36

Alternatively, you can parameterize the IWLAN / PB Link PNIO via the PRESET-PLUG. Details are available in the manual.

Table 8

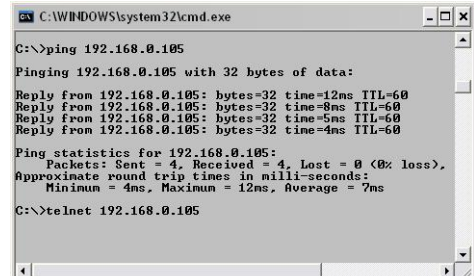
No.	Action	Remark/figure
1.	Configure an access point with the parameters described above.	In this connection we refer to the following chapter: "Parameterizing an access point" or particularly to loading cfg files in the chapter: "Saving and loading the configuration file"
2.	Open an MS-DOS input prompt Start -> Run -> CMD With the command ping 192.168.0.105 you can check whether the IWLAN/PB-Link can be reached. You start the CLI (CommandLineInterface) via telnet 192.168.0.105	 The screenshot shows a Windows command prompt window titled "C:\WINDOWS\system32\cmd.exe". The user has entered the command "C:\>ping 192.168.0.105". The output shows four successful replies from 192.168.0.105 with varying times (12ms, 8ms, 5ms, 4ms) and TTL=60. Below the ping output, the user has entered "C:\>telnet 192.168.0.105".

SIEMENS

Configuring and Commissioning the Example Project

Configuration 6

Entry ID: 23488061

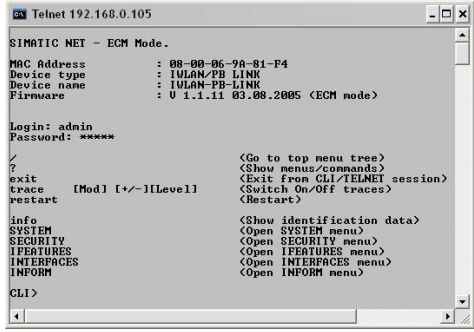
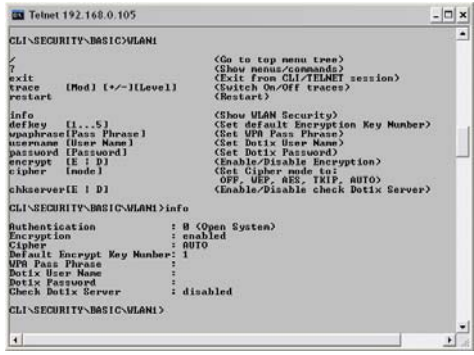
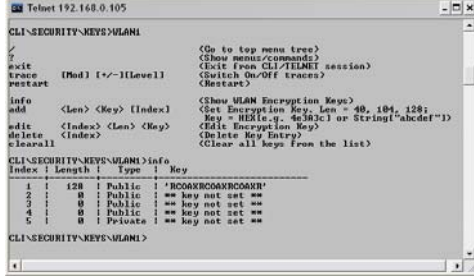
No.	Action	Remark/figure
3.	<p>Login: admin; Password: admin</p> <p>When changing the parameters, you will be asked to restart. However, only start the restart after you have adjusted all important settings.</p> <p>Attention: telnet will automatically stop the connection if there is no entry for 5 minutes. Then you have to log in again.</p>	 <p>You will find an extensive description of the commands of the Command Line Interface (CLI) in the SCALANCE W744 /7/ operating instructions as of page 83.</p>
4.	<p>Example:</p> <p>Via the submenus SECURITY and BASIC you go to the WLAN1 menu (no other submenus).</p> <p>The current parameters are shown when using info.</p> <p>The encryption is switched on with encrypt E.</p> <p>The / command always takes on menu level higher.</p>	
5.	<p>SECURITY>KEYS>WLAN1 menu</p> <p>The info command outputs the current key.</p> <p>edit 1 128 "RCOAXRCOAXROAXR" creates a new key or changes an existing one.</p>	

No.	Action	Remark/figure
6.	<p>The following parameters still have to be adjusted here:</p> <ul style="list-style-type: none"> • Add SSID "RCOAX" • • Activate the channel search in the background • Enable channels 2 and 11 for searching • Activate IPCF-Mode 	<ul style="list-style-type: none"> • CLI\INTERFACES\WLAN1\SSID add RCOAX • CLI\INTERFACES\WLAN1\ADVANCED bkchsel E • CLI\INTERFACES\WLAN1\ADVANCED bkchannel 2 11 • CLI\FEATURES\IPCF\WLAN1 ipcf E
7.	<p>The following parameters should be adjusted:</p> <ul style="list-style-type: none"> • password admin: RCOAX • Transmitting power (office environment) -12db 	<ul style="list-style-type: none"> • CLI\SYSTEM password admin RCOAX • CLI\INTERFACES\WLAN1\ADVANCED power 4
8.	Activate the parameters via restart	restart

Note

The configuration of the IWLAN/PB-LINK PN IO can also be loaded and save via the "config.cfg" file. However, you will need a TFTP server on your PG. In this case, please ask your network administrator.

5.3.2 Parameterizing an access point

The access point W788 is the starting point of an IWLAN. In the following you will learn how to parameterize for this configuration. Please see the manual for detailed information.

After the gradual parameterizing, the saving of the parameterizing into a file is described and how you can load our example configuration. Please bear in mind the changed password for the admin login: "RCOAX".

Table 9

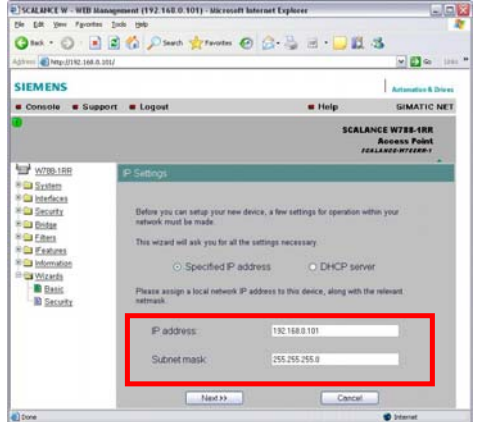
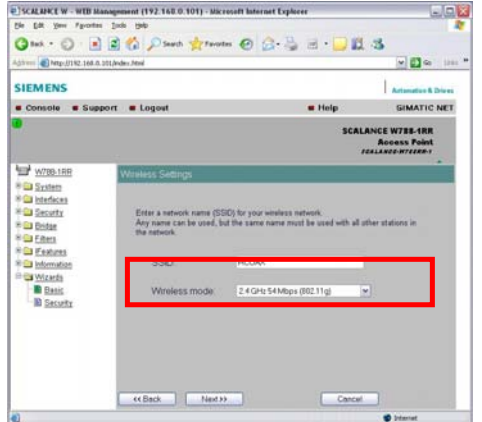
No.	Action	Remark/figure
1.	<p>Start Internet Explorer and enter the IP address of the AP. Login: Admin; Password: admin (in case of factory setting) Prior to a basic configuration, you should process the Wizards first. IP address, subnet mask and device name have already been assigned! Depending on the country code (here "Germany"), other channel settings may be caused.</p>	
2.	<p>Select a network name, frequency and a data rate. When selecting the 5GHz mode you have to use the appropriate accessories (RCOAX cable, connections, terminating resistors, ...)</p>	

SIEMENS

Configuring and Commissioning the Example Project

Configuration 6

Entry ID: 23488061

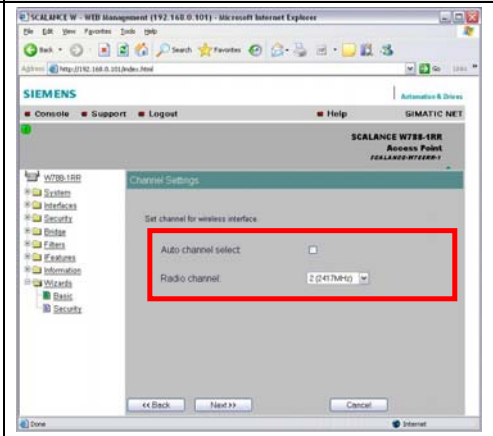
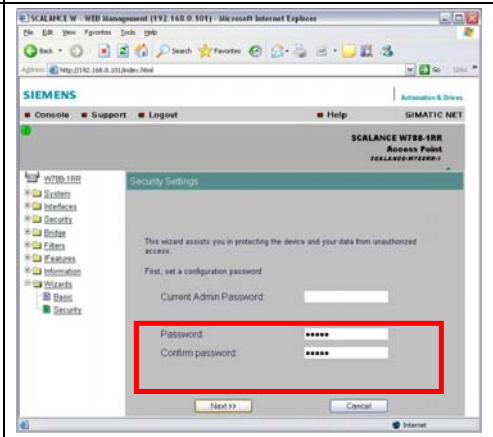
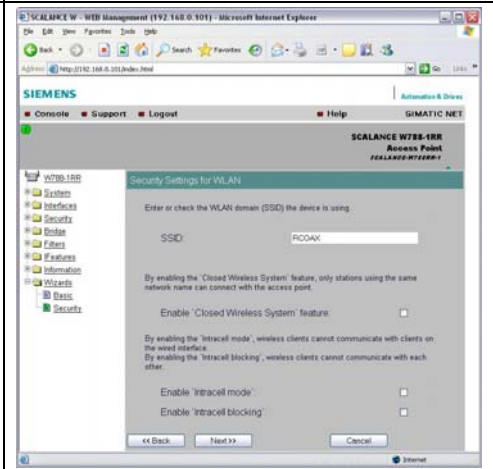
No.	Action	Remark/figure
3.	<p>Select a free channel, but bear in mind that the second access point should be operated with the longest possible distance (here channel 11). Deactivate the free channel selection. For the rapid roaming you later specify the channels which are to be searched through. The BASIC-WIZARD is terminated. In the following you can directly process the SECURITY WIZARD without any restart.</p>	
4.	<p>Start the SECURITY-WIZARD. It is absolutely necessary to protect your settings of your IWLAN components with an own password (here "RCOAX"). On the next page you can further limit your parameterizing option, however, you should refrain from doing so for testing purposes.</p>	
5.	<p>Enter again the SSID with which the system works.</p>	

Copyright © Siemens AG 2009 All rights reserved 23488061_IWLAN_RCOAX_DOKU_V11_e.doc

SIEMENS

Configuring and Commissioning the Example Project

Configuration 6

Entry ID: 23488061

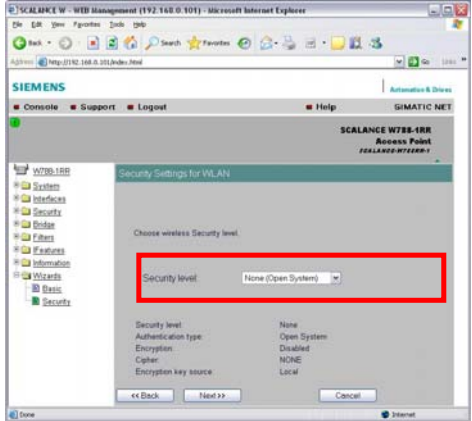
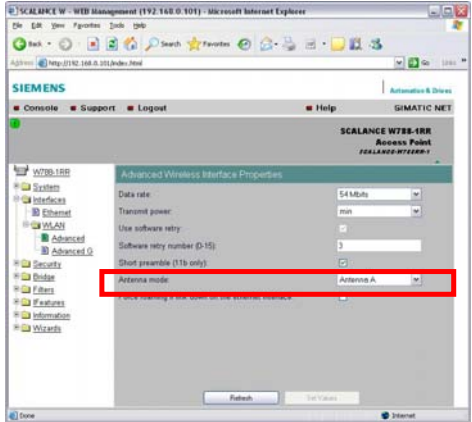
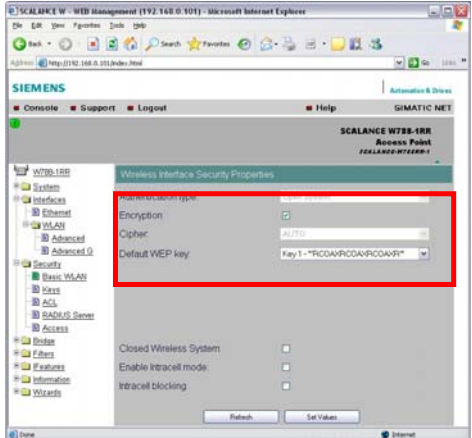
No.	Action	Remark/figure
6.	For the rapid roaming only “None (Open System)” is allowed as Security Level. The extensive security functions will otherwise prevent the necessary fast channel change. In any case, you should use the AES encryption (see Step 9). Then the SECURITY-WIZARD is complete. You can restart the access point and log in with the new password.	
7.	Not all settings are supported by the WIZARDS, particularly the settings for the rapid roaming (iPCF) and RCOAX cable.	Other, necessary changes will be described in the next steps.
8.	For the RCOAX you have to set the antenna connector here and provide the other interface with a terminating resistor. <p style="background-color: yellow; padding: 5px;">Outside the WIZARD, you have to click the “Set Values” button after each entry, otherwise your changes will be rejected when changing the page!</p>	
9.	For safety reasons, definitely activate an encryption. Select a key. You can enter it on the next page.	

Copyright © Siemens AG 2009 All rights reserved
23488061_IWLAN_RCOAX_DOKU_V11_e.doc

SIEMENS

Configuring and Commissioning the Example Project

Configuration 6

Entry ID: 23488061

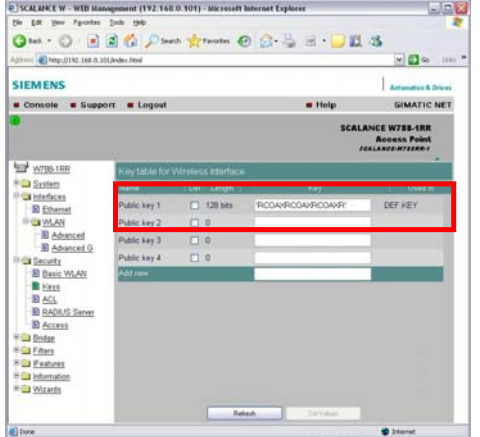
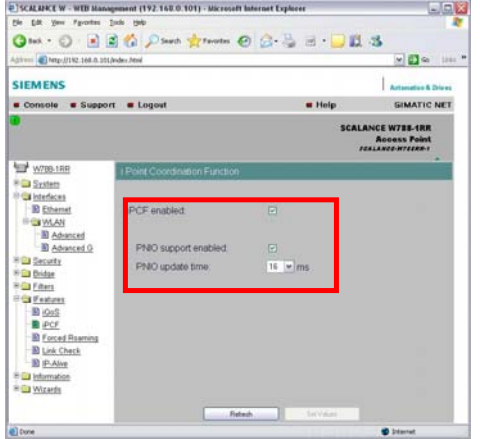
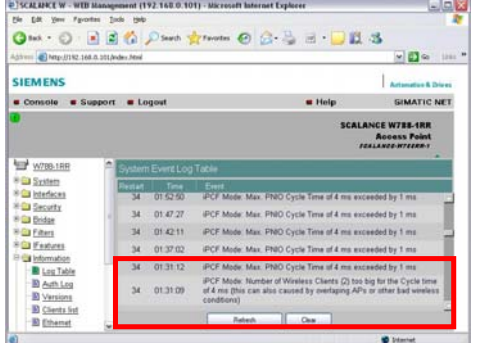
No.	Action	Remark/figure
10.	The degree of encryption depends on the key length. With (exactly) 16 characters we have selected a 128 bit / AES encryption here. You will have to set exactly the same key at all IWLAN devices involved.	
11.	Activate iPCF and the PN IO support. First set the PN IO update time to 16ms. A discussion will be made later on.	
12.	Depending on the network configuration and the radio environment, you can later adjust the PN IO update time.	
13.	<p>Except for the IP address, device name and channel (AP2 = channel 11), the second access point will be parameterized at once.</p> <p>After changing, you should not forget the restart!</p>	Parameterize the access point 2.

 Copyright © Siemens AG 2009 All rights reserved
 23488061_IWLAN_RCOAX_DOKU_V11_e.doc

SIEMENS

Configuring and Commissioning the Example Project

Configuration 6

Entry ID: 23488061

Saving and loading the configuration file

Table 10

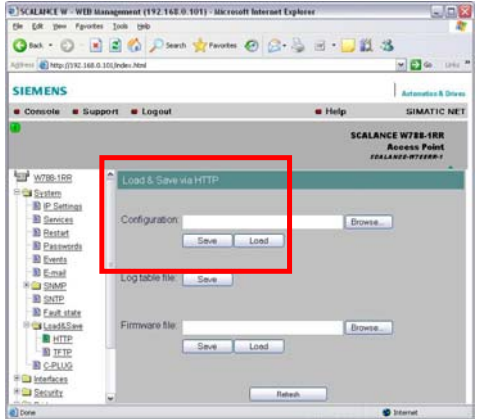
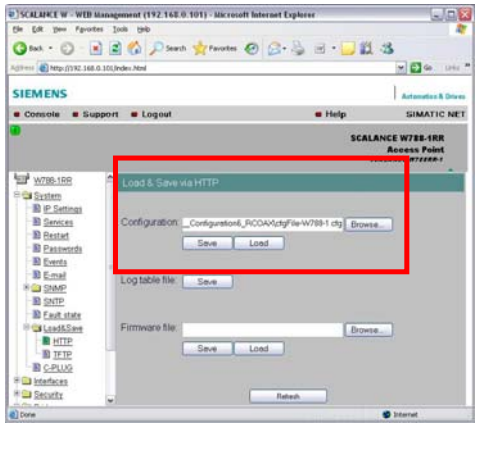
No.	Action	Remark/figure
1.	<p>You can save all settings in one file. Only click the upper "Save" key for saving. Enter the path and the file name for saving into the following standard dialog "File Download" .</p>	
2.	<p>After having loaded the example project and extracted on your PG, you can load the configuration files in same way as your own saving. You set the path and the file name via "Browse..." and then click "Load". Your settings will be activated with an automatic restart.</p> <p>AP1 for initial IBS IWLAN/PB link: cfgFile-W788-1_IWLAN-LINK-CONFIG.cfg</p> <p>AP1: cfgFile-W788-1.cfg AP2: cfgFile-W788-2.cfg CM: cfgFile-W747.cfg</p>	

Copyright © Siemens AG 2009 All rights reserved
23488061_IWLAN_RCOAX_DOKU_V11_e.doc

Parameterizing the client module W747

The client module W747 and the access point W788 are similar in their parameterizing, therefore we will only describe the differences here. Please see the manual for detailed information.

You can also directly load the example configuration, in this connection see Chapter “Saving and loading the configuration file”. Please bear in mind the changed password for the admin login: “RCOAX“ (factory setting “admin”).



Adjust in any case the MAC address of the IM151-3 PN under “Interfaces -> WLAN -> Adopt MAC” to your hardware!

Table 11

No.	Action	Remark/figure
1.	The client module has three Wizards: - Basic, - Security, - iPCF	
2.	The client should only be connected to our SSID and not to other Aps accidentally being within the radio range.	
3.	For PROFINET, the ET200S is to be visible as station, the client module should report with the MAC address of the IM151-3 PN. Consequently, you have to enter the MAC addressed assigned to the module, the address of the example configuration does not work here. This adopted MAC address is the reason why the client module does no longer appear in the PST list or the appropriate Step 7 tool.	

Copyright © Siemens AG 2009 All rights reserved 23488061_IWLAN_RCOAX_DOKU_V11_e.doc

SIEMENS

Configuring and Commissioning the Example Project

Configuration 6

Entry ID: 23488061

No.	Action	Remark/figure
4.	<p>To keep the searching time for a new channel for the rapid roaming as short as possible, restrict the search to a given list. The channels of our two APs 2 & 11 are entered, separated by two blanks.</p> <p>Reduce the transmitting power for e.g. short RCOAX pieces in the office environment to a minimum (here -12db). If you later have to operate many different radio cells closely together, you can reduce the transmitting power with attenuators by additional -30db.</p> <p>For the client module you also have to specify the antenna interface used.</p>	

5.4 Loading the SIMATIC station and testing the S7 functionality

Introduction

The next chapters describe the hardware configuration and the network configuration of the Step 7 project. You also open the example project and follow the setup there.

HW Config and Net Pro

Table 12

No.	Action	Remark/figure
1.	Open the example project “RCOAX” with the SIMATIC Manager.	



Copyright © Siemens AG 2009. All rights reserved. 23488061_IWLAN_RCOAX_DOKU_V11_e.doc

SIEMENS

Configuring and Commissioning the Example Project

Configuration 6

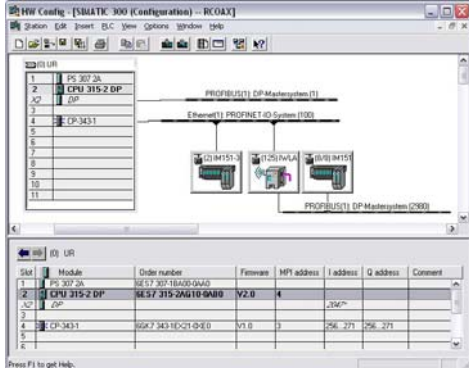
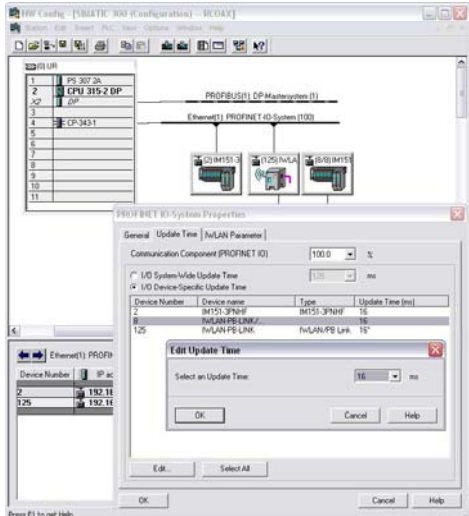
Entry ID: 23488061

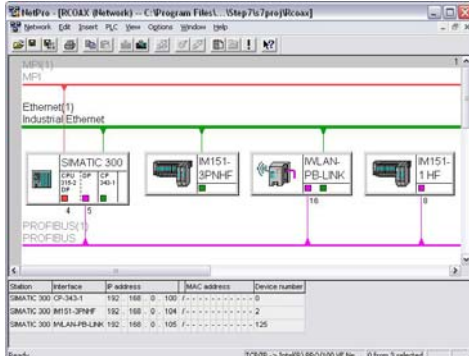
No.	Action	Remark/figure
2.	<p>Structure of the project in HW Config:</p> <ul style="list-style-type: none"> • 1 PS 307 • 2 CPU315 (MPI-Adr. : 4; DP-Adr. : 6) • 3 free • 4 CP343-1 networked with PROFINET <ul style="list-style-type: none"> - ET200S with IM151-3PN - IWLAN/PB link networked with PROFIBUS - ET200S with IM151-1 	
3.	<p>By double-clicking the Profibus line, the properties dialog opens. Under update time, you set the same times as set in the APs (typically 16ms, later you can reduce the time). You can set the communication fraction for the PROFINET IO to 100%, as long as no PROFINET CBA communication (Component Based Automation) takes place. The system has already reserved a sufficient share of time for the acyclic communication (PG accesses etc.). If the PG communication is too slow for your application, you can look for a compromise here.</p>	
4.	<p>In the IWLAN parameter tab, you specify the number of links, i.e. the maximum amount of radio cells simultaneously connected to an access point, in our example both cells can communicate via an AP at the same time, hence the parameter is 2.</p>	
5.	<p>Structure of the project in Net PRO:</p> <p>Compile the configuration and load everything to the CPU. Now the setup is functioning.</p>	

Copyright © Siemens AG 2009 All rights reserved
23488061_IWLAN_RCOAX_DOKU_V11_e.doc

SIEMENS

Configuring and Commissioning the Example Project

Configuration 6

Entry ID: 23488061

PN IO communication via CP343-1

Table 13

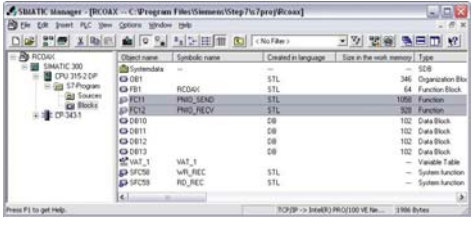
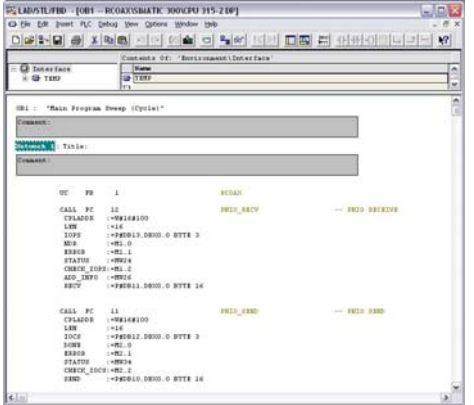
No.	Action	Remark/figure
1.	<p>For communicating with the distributed PN IO I/O you need both modules FC11 PNIO_SEND and FC12 PNIO_RECV from the SIMATIC_NET_CP library. Via the Step 7 help you will get a description. Please also observe the description in the manual “Configuring CPs part A” /6/ as of page A240.</p>	
2.	<p>These modules are cyclically called in OB1.</p>	 <pre> OB1 : "Main Program Overlap (Cyclic)" ----- Comment: ----- Network 1: Title: Comment: ----- UC FB I RETVAL CALL FC 11 PNIO_RECV -- PNIO_RECV CALL FC 12 PNIO_SEND -- PNIO_SEND END </pre>

Copyright © Siemens AG 2009 All rights reserved
23488061_ILWLAN_RCOAX_DOKU_V11_e.doc

Configuration 6

Entry ID: 23488061

No.	Action	Remark/figure
3.	Configuration example:	OB1 STL program code:
	Calling the user program	UC FB 1 // User Program / Simulation
	FC 12 PNIO_RECV	CALL FC 12
	Receiving the I/O signals	CPLADDR := W#16#100
		LEN := 16
		IOPS := P#DB13.DBX0.0 BYTE 3
		NDR := M 1.0
		ERROR := M 1.1
		STATUS := MW 24
		CHECK_IOPS := M 1.2
		ADD_INFO := MW 26
		RECV := P#DB11.DBX0.0 BYTE 16
	FC 11 PNIO_SEND	CALL FC 11
	Sending the I/O signals	CPLADDR := W#16#100
		LEN := 16
		IOCS := P#DB12.DBX0.0 BYTE 3
		DONE := M 2.0
		ERROR := M 2.1
		STATUS := MW 34
		CHECK_IOCS := M 2.2
		SEND := P#DB10.DBX0.0 BYTE 16
	You can program an error evaluation here to evaluate communication failures, e.g. in case the update time has been set too short. You can follow errors up to the failed byte and thus up to the failed ET200S station:	
	Error registration Receive General	U M 1.2
	Error registration Send General	S M 1.3 // General IOPS Fault PNIO_RECV
		U M 2.2
		S M 2.3 // General IOPS Fault PNIO_SEND
	Error registration cell A (without particular error evaluation)	U DB13.DBX 0.0 // IOPS Fault Cell A
		S M 1.4
		U DB12.DBX 0.0 // IOCS Fault Cell A
		S M 2.4
	Error registration cell B (without particular error evaluation)	U DB13.DBX 0.1 // IOPS Fault Cell B
		S M 1.5
		U DB12.DBX 0.1 // IOCS Fault Cell B
		S M 2.5
		BE

 Copyright © Siemens AG 2009 All rights reserved
 23488061_IWLAN_RCOAX_DOKU_V11_e.doc

Configuration 6

Entry ID: 23488061

No.	Action	Remark/figure
4.	In the FB1, inputs and outputs are programmed, which are wired directly together at the station (blinking).	FB1 STL program code: UNDB11.DBX 0.0 // IN 0.0 Cell A = DB10.DBX 0.0 // OUT 0.0 UNDB11.DBX 1.0 // IN 1.0 Cell B = DB10.DBX 1.0 // OUT 1.0 BE

5.5 Function test

Introduction

In the following chapter we will introduce the test and diagnostic functions provided by the used network components:

Log lists via the WEB management

Recorder function via the CLI Command Line Interface

Diagnostic access point W788

For optimizing the update time and the perfect orientation of the antennas, the features described here are offering sufficient information.

Table 14

No.	Action	Remark/figure
1.	Open the WEB management of the active access point (here 192.168.0.101) "and change to the window "Information -> Log Table" Here you get messages about the general state of the access point. <ul style="list-style-type: none"> • Booting • Power supply • Login attempts • Parameter changes and the course of communication <ul style="list-style-type: none"> • other access points • communication failures 	



Copyright © Siemens AG 2009 All rights reserved
23488061_IWLAN_RCOAX_DOKU_V11_e.doc

SIEMENS

Configuring and Commissioning the Example Project

Configuration 6

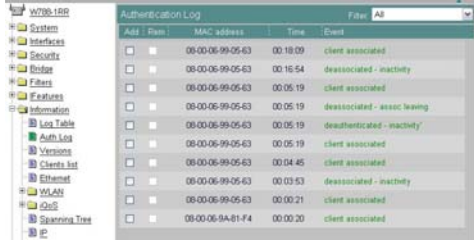
Entry ID: 23488061

No.	Action	Remark/figure																																																							
2.	"Accessible" but undesired access points can block required resources and should be shielded by appropriate measures.	Overlap-AP found: AP 'Workflow' [00:0F:A3:0C:66:6E] found on channel 1 (signal: 21)																																																							
3.	When the radio field overlapping has been removed, as in the previous point, you will have to adjust the update time depending on the configuration (amount of links per AP).	iPCF Mode: Max. PNIO Cycle Time of 4 ms exceeded by 1 ms																																																							
4.	See previous points.	iPCF Mode: Number of Wireless Clients (2) too big for the Cycle time of 4 ms (this can also be caused by overlapping APs or other bad wireless conditions)																																																							
5.	In the Authentication Log you can see which clients are or were connected to this access point.	 <table border="1"> <thead> <tr> <th>Add</th> <th>Item</th> <th>MAC address</th> <th>Time</th> <th>Event</th> </tr> </thead> <tbody> <tr><td><input type="checkbox"/></td><td></td><td>00:00:06:99:05:63</td><td>00:18:09</td><td>client associated</td></tr> <tr><td><input type="checkbox"/></td><td></td><td>00:00:06:99:05:63</td><td>00:16:54</td><td>disassociated - inactivity</td></tr> <tr><td><input type="checkbox"/></td><td></td><td>00:00:06:99:05:63</td><td>00:05:19</td><td>client associated</td></tr> <tr><td><input type="checkbox"/></td><td></td><td>00:00:06:99:05:63</td><td>00:05:19</td><td>disassociated - assoc learning</td></tr> <tr><td><input type="checkbox"/></td><td></td><td>00:00:06:99:05:63</td><td>00:05:19</td><td>deauthenticated - inactivity</td></tr> <tr><td><input type="checkbox"/></td><td></td><td>00:00:06:99:05:63</td><td>00:05:19</td><td>client associated</td></tr> <tr><td><input type="checkbox"/></td><td></td><td>00:00:06:99:05:63</td><td>00:04:45</td><td>client associated</td></tr> <tr><td><input type="checkbox"/></td><td></td><td>00:00:06:99:05:63</td><td>00:03:53</td><td>disassociated - inactivity</td></tr> <tr><td><input type="checkbox"/></td><td></td><td>00:00:06:99:05:63</td><td>00:00:21</td><td>client associated</td></tr> <tr><td><input type="checkbox"/></td><td></td><td>00:00:06:9A:81:F4</td><td>00:00:20</td><td>client associated</td></tr> </tbody> </table>	Add	Item	MAC address	Time	Event	<input type="checkbox"/>		00:00:06:99:05:63	00:18:09	client associated	<input type="checkbox"/>		00:00:06:99:05:63	00:16:54	disassociated - inactivity	<input type="checkbox"/>		00:00:06:99:05:63	00:05:19	client associated	<input type="checkbox"/>		00:00:06:99:05:63	00:05:19	disassociated - assoc learning	<input type="checkbox"/>		00:00:06:99:05:63	00:05:19	deauthenticated - inactivity	<input type="checkbox"/>		00:00:06:99:05:63	00:05:19	client associated	<input type="checkbox"/>		00:00:06:99:05:63	00:04:45	client associated	<input type="checkbox"/>		00:00:06:99:05:63	00:03:53	disassociated - inactivity	<input type="checkbox"/>		00:00:06:99:05:63	00:00:21	client associated	<input type="checkbox"/>		00:00:06:9A:81:F4	00:00:20	client associated
Add	Item	MAC address	Time	Event																																																					
<input type="checkbox"/>		00:00:06:99:05:63	00:18:09	client associated																																																					
<input type="checkbox"/>		00:00:06:99:05:63	00:16:54	disassociated - inactivity																																																					
<input type="checkbox"/>		00:00:06:99:05:63	00:05:19	client associated																																																					
<input type="checkbox"/>		00:00:06:99:05:63	00:05:19	disassociated - assoc learning																																																					
<input type="checkbox"/>		00:00:06:99:05:63	00:05:19	deauthenticated - inactivity																																																					
<input type="checkbox"/>		00:00:06:99:05:63	00:05:19	client associated																																																					
<input type="checkbox"/>		00:00:06:99:05:63	00:04:45	client associated																																																					
<input type="checkbox"/>		00:00:06:99:05:63	00:03:53	disassociated - inactivity																																																					
<input type="checkbox"/>		00:00:06:99:05:63	00:00:21	client associated																																																					
<input type="checkbox"/>		00:00:06:9A:81:F4	00:00:20	client associated																																																					
6.	In the clients list you can see the connected stations with the current signal intensity. You can cyclically update the list with the "Update option". The update time for this update is very long (approx. 3 seconds). Via the CLI (Command Line Interface), which will be described in the next steps, you can work online with 100ms and offline in a file with a resolution of 1ms.	 <table border="1"> <thead> <tr> <th>MAC address</th> <th>SSID</th> <th>Signal</th> <th>Sec</th> <th>Ch</th> <th>State</th> </tr> </thead> <tbody> <tr> <td>00:00:06:9A:81:F4</td> <td></td> <td>1</td> <td>97%</td> <td>x 2</td> <td>Associated</td> </tr> </tbody> </table>	MAC address	SSID	Signal	Sec	Ch	State	00:00:06:9A:81:F4		1	97%	x 2	Associated																																											
MAC address	SSID	Signal	Sec	Ch	State																																																				
00:00:06:9A:81:F4		1	97%	x 2	Associated																																																				

 Copyright © Siemens AG 2009 All rights reserved
 23488061_IWLAN_RCOAX_DOKU_V11_e.doc

SIEMENS

Configuring and Commissioning the Example Project

Configuration 6

Entry ID: 23488061

Diagnostic client module W747

Table 15

No.	Action	Remark/figure
1.	<p>Open the WEB management of the client module (here 192.168.0.103) and change to the window “Information -> Available WLAN”</p> <p>Apart from the MAC address and the channel you will see the signal intensity to which the client and the access point are connected.</p> <p>You can cyclically update the list with the “Update option”.</p> <p>The update time for this update is very long (approx. 3 seconds). Via the CLI (Command Line Interface), which will be described in the next steps, you can work online with 100ms and offline in a file with a resolution of 1ms.</p>	

Diagnostic IWLAN / PB Link PN IO / Recorder function

When opening and operating the CLI please refer to SCALANCE W747 /3/ in the previous chapters and the operating instructions. In principle the same applies to the client module W747.

Table 16

No.	Action	Remark/figure
1.	<p>Open an MS-DOS input prompt and start the CLI (CommandLineInterface) via telnet 192.168.0.105</p> <p>and change to the window “Inform” then “Signal”</p>	

Copyright © Siemens AG 2009 All rights reserved
23488061_IWLAN_RCOAX_DOKU_V11_e.doc

SIEMENS

Configuring and Commissioning the Example Project

Configuration 6

Entry ID: 23488061

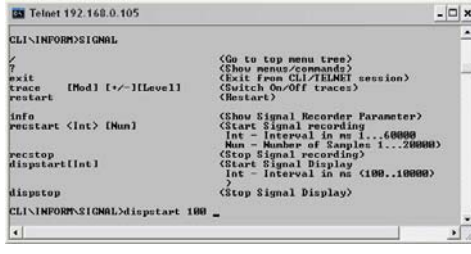
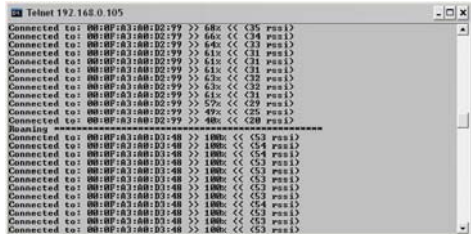
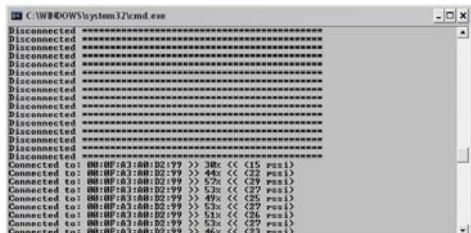
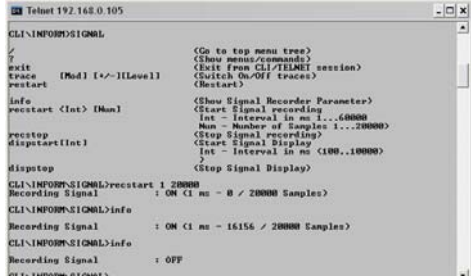
No.	Action	Remark/figure
2.	<p>Start the online recorder with the minimum resolution of 100ms: dispstart 100 ↵ You can stop the display with the command dispstop ↵ which you simply enter into the running recorder.</p>	
3.	<p>Apart from the MAC address of the access point to which the IWLAN/PB link is connected, the field intensity is displayed. "rssi" (Received Signal Strength Indication) represents an indicator for the receiving field intensity of cordless communication applications (producer-specific). At the place marked with Roaming ****, you can see the change from the fading AP 99 to the new AP 48 with a field intensity of 100%.</p>	
4.	<p>If you have established a connection to the land-line network with your PG (as described in the hardware configuration), the connection to the IWLAN/PB link will be interrupted, if the new AP is not found fast enough. Only when the connection is reestablished, the display will continue. If the interruption is longer than the time-out interval, the telnet session will be terminated and will have to be restarted.</p>	
5.	<p>Offline recorder You can record the behavior with a resolution of 1ms: recstart 1 20000 At least 1ms with a maximum of 20000 data files From time to time you can display the progress with info</p>	

Copyright © Siemens AG 2009 All rights reserved
23488061_IWLAN_RCOAX_DOKU_V11_e.doc

SIEMENS

Configuring and Commissioning the Example Project

Configuration 6

Entry ID: 23488061

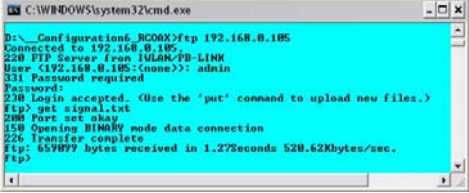
No.	Action	Remark/figure
6.	<p>All recorded data are stored in the signal.txt file, which you have to read via ftp:</p> <p>Open an MS-DOS input prompt</p> <p>Start -> Run -> CMD</p> <p>Change to the directory where you want to store the file (here D:__Configuration6_RCOAX). Start ftp 192.168.0.105</p> <p>User and password as configured admin</p> <p>RCOAX</p> <p>Reading the file: get signal.txt</p> <p>Complete the ftp with bye</p>	
7.	<p>Contents of the signal.txt file:</p> <p>MAC MAC address current access point</p> <p>Sample: Data record number</p> <p>Signal: Field intensity</p> <p>RSSI: Signal intensity</p> <p>Roaming: Changing to another AP</p> <p>Roaming from AP 48 to AP 99</p> <p>Connection break off (MAC address and signal intensity is "0")</p> <p>Connected to AP 99</p>	<p>20000 Samples Recorded with 1 ms Interval</p> <p>MAC, Sample, Signal, RSSI, Roaming</p> <p>00:0F:A3:A0:D3:48,1,100,52,100</p> <p>00:0F:A3:A0:D3:48,2,100,52,100</p> <p>00:0F:A3:A0:D3:48,3,100,52,100</p> <p>***</p> <p>00:0F:A3:A0:D3:48,637,47,24,100</p> <p>00:0F:A3:A0:D3:48,638,47,24,100</p> <p>00:0F:A3:A0:D3:48,639,47,24,100</p> <p>00:0F:A3:A0:D2:99,640,47,24,0</p> <p>00:0F:A3:A0:D2:99,641,47,24,0</p> <p>00:0F:A3:A0:D2:99,642,57,29,0</p> <p>***</p> <p>00:0F:A3:A0:D2:99,4962,53,27,0</p> <p>00:0F:A3:A0:D2:99,4963,53,27,0</p> <p>00:00:00:00:00:00,4964,0,0,100</p> <p>00:00:00:00:00:00,4965,0,0,100</p> <p>***</p> <p>00:00:00:00:00:00,6057,0,0,100</p> <p>00:00:00:00:00:00,6058,0,0,100</p> <p>00:0F:A3:A0:D2:99,6059,46,23,0</p> <p>00:0F:A3:A0:D2:99,6060,46,23,0</p> <p>***</p>

5.6 Update time in PN IO systems

Introduction

Within an update time, all IO devices in the IO system have been supplied with new data by the IO controller (outputs), and all IO devices have sent their new data to the IO controller (inputs).

When setting up PROFINET with Industrial Wireless LAN, then you will possibly have to adjust the update time for wireless devices. The IWLAN interface has a smaller performance than the wire-bound data network.

Furthermore, the maximum amount of the devices simultaneously assigned to an AP plays a decisive role.

Note

Update times for the cyclic data exchange
STEP 7 determines the update time on the basis of the existing hardware configuration and the resulting cyclic data load.
Within this time, a PROFINET IO device has exchanged its user data with the respective IO-Controller.
The update time can be set to a complete bus segment of a controller as well as to an individual IO device. In Step 7 you can manually extend the update time.
If you need to consider additional cyclic PROFINET services (e.g. cyclic services for PROFINET CBA) apart from the PROFINET IO:
Set an update time for the respective device in STEP 7 / HW Config with the dialog which is to be reserved for PROFINET IO. You will find further details in the online help of STEP 7.

Note

Further details are provided in "PN response time for typical configurations" /8/ /9/

Setting the update time

The parameters described in the following can be seen and set in the properties dialog of PROFINET IO system in HW Config.

Update times are only possible in certain grids (e. g. 4, 8, 16ms). The values being a possibility are determined by STEP 7 from the properties of the respective IO device.

If you want to change the underlying hardware configuration, e.g. add new IO devices, the update time can change. When opening the dialog the next time, a message will inform you about the change.

The default value for the update time will automatically be calculated depending on the maximum amount of the links to an IWLAN segment (or AP).



Attention

Please note that you have to select the update time for the SCALANCE W788-1RR identically with the setting for the IWLAN/PB link PN IO and the IM151-3PN in the STEP 7 configuration.

“Update time” tab

Communication fraction (PROFINET IO)

In case a cyclic data exchange takes place at the same Ethernet subnet via PROFINET IO and PROFINET CBA (Component Based Automation), you will have to define the communication fraction for PROFINET IO there.

Note

If you set a communication fraction of 100%, the PG functions (e.g. loading of programs) or the communication services of individual IO controllers may slow down.

Remedy: Reduce the communication fraction so much that these functions run in an acceptable speed. Then check whether the resulting update time will be sufficient for the application.

IO system-wide / IO device-specific update time

STEP 7 automatically calculates an update time from the available hardware configuration and the resulting cyclic data load, from the module properties and the communication fraction for the PROFINET IO.

In case of the option "IO system-wide update time", STEP 7 calculates a perfect update time for all IO devices of the PROFINET IO system exchanging I/O data. You can increase but not reduce this update time.

In case of the option "IO device-specific update time", STEP 7 calculates a perfect update time individually for each IO device of the PROFINET IO. You can change these update time individually or in groups (by multi-selection). You can generally reduce the update times of individual IO devices once more, if you first increase the update times of other IO

devices and if the specifically shortest update time for the respective IO-Device has not been reached.

“Update time” column

Display of the automatically calculated or reconfigured update time.

“IWLAN parameter” tab**Maximum number of devices in an IWLAN segment**

If there are several IWLAN/PB links within a segment, they will have to share the band width being available for the radio transmission. This will cause an extension of the update time for these devices.

Example: If there are not more than a maximum of two IWLAN/PB links in an IWLAN segment at the same time, enter a “2”.

Optimizing the update time

By specifying the maximum number of links in your system in the "IWLAN parameter" tab you can optimize the update time.

**Attention**

If you select the update time too short or if there are more links at the IWLAN segment than specified in the "IWLAN parameter", connection breakdowns may be caused. Therefore we recommend to maintain the default settings.

When optimizing the update time it is absolutely necessary to consider the following items, as otherwise you will take the risk that a stable communication cannot be set up.

Your system is operated with several radio segments and with more than 2 channels and the clients change between the segments (roaming). **The selected PN IO update time should not be shorter than 16ms.**

Note

More in-depth information regarding the configuration of Wireless LANs can be found in the document "Guideline for the Use of Industrial Wireless LAN in a PROFINET IO Environment" (<http://support.automation.siemens.com/WW/view/en/31938420>)

**Attention**

We strongly recommend checking the local radio conditions before commissioning.

To restrict the amount of channels on which W747 and IWLAN/PB link PN IO are looking for an AP, you have to make the following settings in the "Interfaces WLAN Advanced" menu which will optimize the roaming behavior in terms of time:

Background scan channel select -> activates the background scan

Background scan channels -> selection of the channels to be scanned

Configuration 6

Entry ID: 23488061

6 Technical Data

SCALANCE W788 and W747

Table 17

Data transmission	
Transmission rate Ethernet	10/100 Mbit/s
Transmission rate radio	1 - 54 Mbit/s (108 Mbit/s)
Supported standards radio	802.1x, 802.11a, 802.11b, 802.11g, 802.11h, 802.11i
Supported standards power supply	802.3af (Power over Ethernet)
Interfaces	
Power	<ul style="list-style-type: none"> M12 connector plug (18 ... 32 V DC) Power contacts in the hybrid plug (18 ... 32 V DC) RJ45 socket over Ethernet (48 V DC) 2 supplies 24 V DC (18 ... 32 V DC) safety extra-low voltage
Data	<ul style="list-style-type: none"> IE IP 67 hybrid plug connector R-SMA antenna sockets
Current consumption	< 10 W
MTBF	67 years

IWLAN/PB Link PN IO

Table 18

Data transmission	
Transmission rate radio	1..54 Mbit/s
Supported standards radio	802.11a, 802.11b, 802.11g
PROFIBUS	9.6 kbit/s, 19.2 kbit/s, 45.45 kbit/s, 93.75 kbit/s, 187.5 kbit/s, 500 kbit/s, 1.5 Mbit/s, 3 Mbit/s, 6 Mbit/s, 12 Mbit/s
Maximum segment length for PROFIBUS	20 m
Maximum power consumption at the PROFIBUS interface	100 mA at 5V
Interfaces	
Industrial Wireless LAN	R-SMA antenna socket
Connection to PROFIBUS	9 pole Sub-D female
Supply voltage	2 supplies for DC +20.4 V to 28.8 V
Power consumption from DC 24V external	Approx. 0.3 A (typical for 24 V)
Power loss	6.5 W

SIEMENS

Technical Data

Configuration 6

Entry ID: 23488061

IM151-3 PN HF

Table 19

Data transmission	
Transmission rate	<ul style="list-style-type: none"> • 10 MBit/s for Ethernet services • 100 MBit/s full duplex for PROFINET IO
Transmission procedure	100BASE-TX
Bus protocol	PROFINET IO TCP/IP
Supported Ethernet services	<ul style="list-style-type: none"> • ping • arp • Network diagnostic (SNMP) / MIB-2
PROFINET interface	2x RJ45
Voltages, currents, potentials	
Rated supply voltage of the electronics	DC 24 V
Power consumption from the rated supply voltage	Approx. 200 mA
Power loss of the module	Approx. 2 W

SCALANCE X204 Switch

Table 20

Interfaces	
Connection of end devices or network components via Twisted Pair	4xRJ45 socket, 10/100 Mbit/s TP
Connection for power supply	1x4-pole plug-in terminal block
Connection for signal contact	1x2-pole plug-in terminal block
Supply voltage	
	2 x DC 24 V
Current consumption	
	215 mA
Degree of protection	
	IP30

Configuration 6

Entry ID: 23488061

CP 343-1 (343-1 EX21)

Table 21:

Criterion	Basic performance data
Supply voltage	24 V DC
Current consumption	Typ. 160 mA ;max. 200 mA from 24 V DC external
Ethernet interface	RJ45
Transmission rate	10/100 Mbit/s autosensing
S7 communication	Max. of 16 connections
S5-compatible communication (Send/Receive)	Max. of 16 connections
PG/OP communication	Max. of 16 connections
Multi-protocol operation	ISO, TCP/IP, UDP, RFC 1006
Sum of simultaneously operable connections	Maximum of 48
Profinet IO controller	
Amount of operable PN IO devices	125

Helix antenna for RCoax cable (2.4 GHz)

Table 22

Electrical properties	
<ul style="list-style-type: none"> Frequency range Impedance VSWR Antenna profit at 2.4 GHz Polarity 	2.4 ~ 2.4835 GHz 50 Ω ≤ 1.8 4 dBi circularly rotating clockwise
Permissible ambient conditions	
<ul style="list-style-type: none"> Degree of protection Ambient temperature 	IP 65 - 20°C to + 60°C

RCoax cables

The data refer to the two RCoax cables with the MLFB numbers 6XV1875-2A for 2.4 GHz and 6XV1875-2D for 5 GHz.

Table 23

Device design 2.4 GHz / 5 GHz	
<ul style="list-style-type: none"> Inner conductor Dielectric Outer conductor 	Copper-clad aluminum, Diameter: 4.8 mm Polyethylene foam Diameter: 12.4 mm

SIEMENS

Technical Data

Configuration 6

Entry ID: 23488061

Device design 2.4 GHz / 5 GHz	
<ul style="list-style-type: none"> Cable jacket 	Overlapping copper foil with slot groups, bonded to the cable jacket Polyethylene, pastel turquoise Diameter: 15.5 mm Jacket thickness 1.3 mm
Mechanical properties 2.4 GHz / 5 GHz	
<ul style="list-style-type: none"> Smallest bending radius Tensile strength Weight 	20 cm (unique) 110 daN (1daN = 10 N) 0.232 kg/m
Electrical properties 2.4 GHz / 5 GHz	
<ul style="list-style-type: none"> Impedance Ratio of the propagation rate Capacity Resistance in case at 20°C <ul style="list-style-type: none"> Inner conductor: Outer conductor: 	50 +/- 2 Ω 88% 76 pF/m DC 1.48 Ω /km 2.9 Ω /km
Permissible ambient properties 2.4 GHz / 5 GHz	
<ul style="list-style-type: none"> Operating temperature Installation temperature 	- 40°C to + 85°C - 25°C to + 60°C

Copyright © Siemens AG 2009 All rights reserved
 23488061_IWLAN_RCOAX_DOKU_V11_e.doc

7 Important Terms and Bibliographic References

Access points

Many WLAN clients (end devices) can log in at an AP and can exchange data with each other via this AP. Comparable to a Switch, switching network cards of several end devices to a parallel data bus in the cable-based Ethernet, the Access Point provides a radio-based data bus via which the logged in end devices can exchange data.

Update time

Within an update time, all IO devices in the IO system have been supplied with new data by the IO controller (outputs), and all IO devices have sent their new data to the IO controller (inputs).

Industrial Wireless LAN

Apart from the data communication according to the Standard IEEE 802.11, the Industrial Wireless LAN of SIMATIC NET also offers a multitude of extensions (I features) being very useful for the industrial customer. IWLAN is particularly suitable for demanding industrial applications requiring a reliable radio communication due to:

- Automatic roaming in case of interruption of the connection to the Industrial Ethernet (Rapid Roaming)
- Cost saving when using an individual radio network for safely operating an processor either for process-critical data (e.g. alarm message) or for uncritical communication (e.g. service and diagnostic)
- Cost-efficient connection to devices in remote environments difficult to reach

iPCF

Industrial Point Coordination Function: Method for controlling the data traffic of a radio cell with the access point. In case of large station numbers, collisions can be avoided with the iPCF, thus increasing the data throughput. Furthermore the iPCF enables a fast change of the radio cell (Rapid Roaming). iPCF is optimized for being used in RCoax cables, and in this configuration it reaches the perfect performance. iPCF is a standard optimized for fast roaming and a deterministic transmission. During the current security mechanisms 802.1x and WPA, keys are negotiated in relatively time-consuming mechanisms, therefore these methods are not available at iPCF.

Isochronous real-time

Isochronous real-time communication (PROFINET V3) is a transmission procedure where a part of the transmission time is reserved for the cyclic data transmission (deterministic). The communication cycle is divided in a deterministic part and in an open part. The cyclic IRT messages are sent in a deterministic channel, whereas the TCP/IP and RT messages are sent in an open channel. In this way, both data transmissions exist side by side without disturbing each other.

When implementing the transmission procedure in the ERTEC-ASICs (Enhanced Real-Time Ethernet Controller), you will reach cycle times of less than 1 ms and a jitter accuracy of less than 1µs.

Coaxial cable, RCoax

The coaxial cable – also referred to as "Coax" – is a metallic conductor system, which is used in the high-frequency transmission, e.g. as an antenna cable for radio and TV devices, and also for modern networks where high transmission speeds are demanded. In case of a coaxial cable, an inner conductor is covered by an outer, hose-shaped one. Both conductors are separated by a plastic insulation. Unlike other cables, this structure is characterized by a high interference immunity and small electromagnetic radiation.

In contrast, RCoax or leaky wave cables have a defined radiant behavior.

In the industrial communication, mainly two cable types are used:

- Cable in the radiation module for standard applications.
The outer conductor of these cables is provided in regular intervals with slots vertical to the cable axis.
- Cable in coupling mode for the data transmission in the close range of the cable.
The outer conductor is provided with a continuous slot parallel to the cable axis or has small openings whose intervals to each other are much smaller than half of the wave length.

PROFINET

In the scope of Totally Integrated Automation (TIA) PROFINET is the logical continuation of:

- PROFIBUS DP, the established field bus, and
- Industrial Ethernet, the communication bus for cell levels.

The experiences from both systems have been integrated into PROFINET. PROFINET as an Ethernet-based automation standard of PROFIBUS International defines a cross-vendor communication and engineering model.

PROFINET CBA

In the scope of PROFINET, PROFINET CBA (Component Based Automation) is an automation concept

- for realizing modular application with distributed intelligence
- for the machine-to-machine communication

With PROFINET CBA, you create a distributed automation solution on the basis of prepared components and partial solutions. This concept suits very well with the demands for a higher modularization in the mechanical and process plant engineering by largely decentralizing the intelligent processing. Component Based Automation provides that these completely technological modules can be used as standardized components in large systems.

PROFINET IO

In the scope of PROFINET, PROFINET IO is a communication concept for realizing modular, distributed applications. With PROFINET IO you create automation solutions which you know from PROFIBUS and you are familiar with. On the one hand, PROFINET IO is realized by the PROFINET standard for automation devices and on the other hand by the engineering tool STEP 7. This means that the STEP 7 provides the same application view as regardless of whether you configure with PROFINET devices or PROFIBUS devices. The programming of your user program is the same for PROFINET IO and PROFIBUS DP, if you use the modules and system states lists extended for PROFINET IO.

PROFINET IO controller

A device which can be addressed via the connected IO devices. This means: the IO Controller exchanges input and output signals with allocated field devices. The IO controller is often the controller in which the automation program runs.

PROFINET IO device

Distributed field device allocated to an IO controller (e.g. remote IO, valve terminals, frequency inverter, switches)

Proxy The PROFINET device with a proxy functionality is the representative of a PROFIBUS device at the Ethernet. Via the proxy functionality a PROFIBUS device can not only communicate with its master but also with all stations at the PROFNET. In case of PROFINET, you can integrate existing PROFIBUS systems by means of, e.g., an IE/PB link or a CPU 31x-2 PN/DP into the PROFINET communication. In place of the PROFIBUS components, the IE/PB link/the CPU takes up the communication via PROFINET. In this way you can connect DPV0 as well as DPV1 slaves to PROFINET.

PST Primary Setup Tool: The new STEP 7 versions contain the functionality. This enables you to set and read device names, IP addresses and other parameters. Uses DCP. Download under entry ID [19440762](#)

Real time

Real time means that a system is processing external events in a defined time.

Determinism means that a system reacts predictably (deterministic).

Both requirements are important for industrial networks.

PROFINET meets this requirements.

Consequently, PROFINET, as a deterministic real time network, is made up as follows:

The transfer of time-critical data takes place in guaranteed time intervals. For this purpose, PROFINET offers an optimized communication channel for real-time communication: Real-Time (RT).

- An exact determination (forecast) of the transfer time is possible.
- The smooth communication in same network via other standard protocols is ensured.

telnet Teletype Network is a widespread network protocol.

Configuration 6

Entry ID: 23488061

tftp server

Trivial File Transfer Protocol is a very simple file transmission protocol.

Configuration 6

Entry ID: 23488061

Literature

- /1/** RCOAX System Manual (C79000-G8900-C189-04)
<http://support.automation.siemens.com/WW/view/en/21286952>
- /2/** SCALANCE W78x Operating Instructions (C79000-G8900-C184-06)
<http://support.automation.siemens.com/WW/view/en/19384623>
- /3/** SCALANCE W74x Operating Instructions (C79000-G8900-C185-06)
<http://support.automation.siemens.com/WW/view/en/19386812>
- /4/** Assembly Instructions for Modular Outlet with Power Insert (A5E00343974)
<http://support.automation.siemens.com/WW/view/en/20695652>
- /5/** IWLAN/PB Link PN IO Manual; (C79000-G8900-C200-02)
<http://support.automation.siemens.com/WW/view/en/21379908>
- /6/** S7-CPs for Industrial Ethernet Configuring and Commissioning (C79000-G8900-C182-05)
<http://support.automation.siemens.com/WW/view/en/16512249>
- /7/** General Information on the ET 200S Distributed I/O System Operating Instructions (A5E00515770-03)
<http://support.automation.siemens.com/WW/view/en/1144348>
- /8/** Determination of the PN response time for typical configurations in the PROFINET IO
<http://support.automation.siemens.com/WW/view/en/21869080>
- /9/** Determination of the PN/DP response time for typical configurations of IO controllers and DP slaves via IE/PB link or IWLAN/PB link.
<http://support.automation.siemens.com/WW/view/en/21869196>
- /10/** PROFINET System Description, (A5E00298287-02)
<http://support.automation.siemens.com/WW/view/en/19826727>
- /11/** IWLAN Setup of a Wireless LAN in the Industrial Environment
<http://support.automation.siemens.com/WW/view/en/22681042>