

Moxa White Paper

Requirements for Ethernet Networks in Substation Automation

Alvis Chen

Introduction

Ethernet offers numerous advantages that make it the communication medium of choice for substation automation systems around the world, including superior range, versatility, and speed. However, there are special considerations that must be made in order to ensure maximum performance and reliability for the conditions and requirements of power substations. This white paper presents several of the most important items that power utility administrators should consider when setting up an Ethernet network for a substation.

Certification and Hardware Requirements

IEC 61850-3

Power substations are characterized by harsh operating conditions and high levels of electromagnetic radiation. Communication equipment used in substations must be designed for operation under such conditions. Due to the critical nature of substation operations, communication devices must also exhibit much higher standards of reliability than is expected in other fields. Device certification is an important method to ensure that a network device is suitable for deployment in a substation automation system.

The International Electrotechnical Commission (IEC) is an international standards organization created by experts from

Released January 2008

Copyright © 2008 Moxa Inc. All rights reserved.

MOXA manufactures one of the world's leading brands of device networking solutions. Products include industrial embedded computers, industrial Ethernet switches, serial device servers, multiport serial cards, embedded device servers, and remote I/O servers. Our products are key components of many networking applications, including industrial automation, manufacturing, POS, and medical treatment facilities.

How to contact Moxa

Tel: 1-714-528-6777
Fax: 1-714-528-6778
Web: www.moxa.com
Email: info@moxa.com



This document was produced by the Moxa Technical Writing Center (TWC). Please send your comments or suggestions about this or other Moxa documents to twc@moxa.com.

Moxa White Paper

the major developed countries. IEC 61850 was proposed as a single, global, future-proof standard for substation communications. Part three of IEC 61850 (IEC 61850-3) specifically addresses environmental and electromagnetic interference (EMI) immunity for communications networks and systems in substations. Certification for IEC 61850-3 has become a useful baseline requirement for communication devices in substations, and is widely referred to around the world.

The EMI immunity requirements for substation communication devices are based on IEC 61000-6-5 (Generic standards – immunity for power station and substation environments), which establishes performance criteria for key substation functions. To be compliant with the standard, critical functions must experience no delays or data loss when exposed to various EMI disturbances. Examples of critical functions include protection and teleprotection functions, on-line processing and regulation, and metering. Detailed requirements and test procedures are specified in the IEC 61000-4-x series and cover the following:

- Electrostatic discharge immunity
- Radiated, radio-frequency, electromagnetic field immunity
- Electrical fast transient/burst immunity
- Surge immunity
- Immunity to conducted disturbances, induced by radio-frequency fields
- Power frequency magnetic field immunity
- Oscillatory waves immunity
- Immunity to conducted, common mode disturbances in the frequency range 0 Hz to 150 kHz.
- Ripple on DC input power port immunity
- Voltage dips, short interruptions and voltage variations on DC input power port immunity

Moxa White Paper

IEEE 1613

IEEE 1613 is another industry standard and was developed by a Power Engineering Society (PES) task force. It also specifies EMI immunity requirements for networking devices in electric power substations. Included in IEEE 1613 are ratings, environmental performance requirements, and testing requirements for compliant communication devices. Compliant devices may not experience permanent damage under EMI stress.

Two classes of compliant devices are defined according to how EMI stress affects performance. Class 1 devices may experience some data errors, loss, or delays under EMI stress conditions. Class 2 devices must not experience any data errors, delays or loss under EMI stress conditions. Testing procedures and requirements are specified in the IEEE C37.90.x series and cover the following:

- ESD
- Radiated RFI
- Fast transient
- Oscillatory
- Dielectric strength

By using network devices that are certified for both IEEE 1613 and IEC 61850-3, power utility administrators can be assured of solid performance and reliability in harsh substation environments.

Fiber Optic Media

The communication media used for substations networks must be well-protected from severe electrical interference. In addition, networks may span great distances, which can require special and expensive accommodations. Fiber optic media is ideally suited for substation networks, since it is immune to electrical noise and allows high-speed, high-bandwidth transmission over great distances. Ethernet switches that support long-haul single mode optical fiber are

Moxa White Paper

capable of transmitting data at 100 Mbps over distances of up to 80 km, without the need for repeaters.

Modular Design

It can be difficult to make accurate predictions of future power and network requirements. The demand for power continues to grow around the world, and regional power grids are constantly being expanded through new substations or additions. In many cases, actual demand outpaces the best forecasts, sometimes dramatically. The ability to expand network size, bandwidth, and speed with ease and flexibility is therefore a very important and valuable feature, especially for substations in rapidly developing regions.

Some Ethernet switch manufacturers offer expandable, modular switch systems that address this need. The modular switch design is a powerful way to ensure that a substation automation system is equipped to handle both present and future network requirements. For maximum flexibility, high-grade network connections should be supported with both Gigabit and Fast Ethernet interfaces.

Industrial-Grade Construction

Networking devices at power utility substations face much harsher operating conditions than the devices used in office automation environments. Not only is EMI protection required, industrial-grade construction is absolutely necessary. In particular, communication devices used in substation automation systems should be characterized by the following:

- Wide operating temperature range (-40°C to 85°C)
- Rugged metal chassis
- Vibration and shock protection
- Rackmount or DIN-rail installation
- Power redundancy with AC and DC inputs

Moxa White Paper

Network Architecture

Redundancy and Recovery Time

Network redundancy is a basic requirement for automation systems since it ensures a high degree of network reliability. In redundant network topologies, a backup path is established for use when part of the network becomes unavailable. Different topologies such as dual networks can be employed and require specially designed switches and protocols.

The Ethernet ring topology has become the preferred choice for substation automation systems due to its flexibility, lower overhead, and easier installation. A ring topology can be implemented using IEEE 802.1D Spanning Tree Protocol (STP) or IEEE 802.1W Rapid Spanning Tree Protocol (RSTP). However, the network recovery time when using STP or RSTP is between 1 and 60 seconds. This kind of delay can cause serious problems for complex substation automation systems. Generally speaking, a substation network should automatically recover within 100 milliseconds to minimize any disruption to the automation system. Proprietary protocols for ring topologies are available with recovery times in the millisecond range.

Simple Ring Topology

An example of an Ethernet ring topology is shown below. The ring topology is applied to a basic substation communication structure and can be established using STP, RSTP, or proprietary protocols. Intelligent electronic devices (IEDs) are used to control electrical equipment such as protection relays, meters, and circuit breakers. All IEDs are controlled by a local control room or by a remote dispatch center.

Moxa White Paper

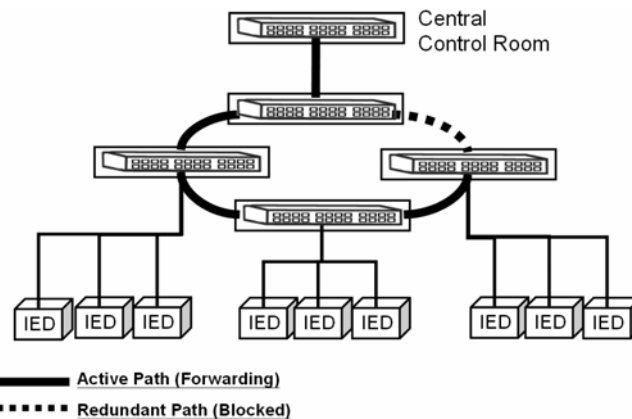

Each switch runs the ring protocol and is connected in a ring topology. One of the paths serves as the backup path and is blocked during regular operation. If any connection fails, the ring protocol restores network communication using the backup network path.

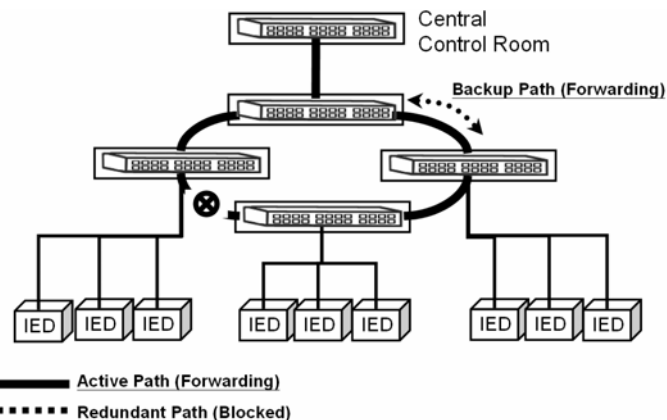

Complex Ring Topologies

The ring topology can be expanded to a large number of switches, but it can be difficult to manage or install very large rings, especially over great distances. In addition, network recovery times increase with the size of the ring.

Often, it is more effective to establish a number of smaller rings based on location and system (e.g., one ring for the control center, one ring for the IEDs). Redundant connections can be

Moxa White Paper

established between these rings, using different methods depending on network requirements and physical layout.

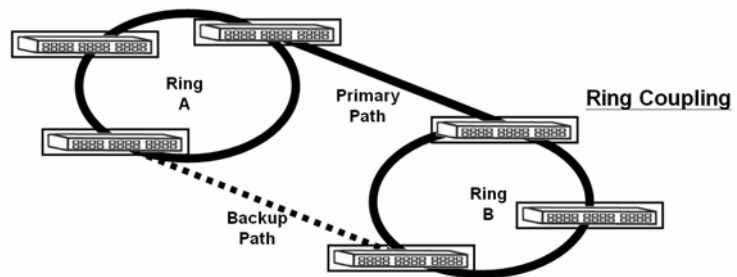
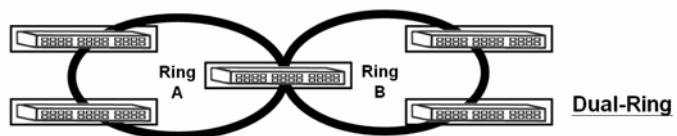
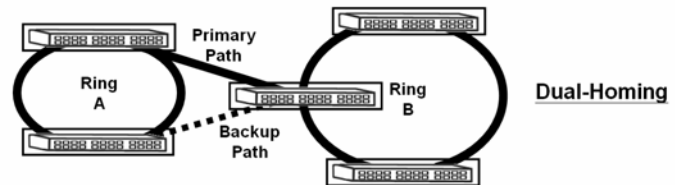

Shown below is an example of dual-homing in a substation automation system. The failure of any connection or switch in the ring will not cause a disruption in network communication. The redundant ring protocol immediately restores network communication, and the system runs without interruption.

Moxa White Paper

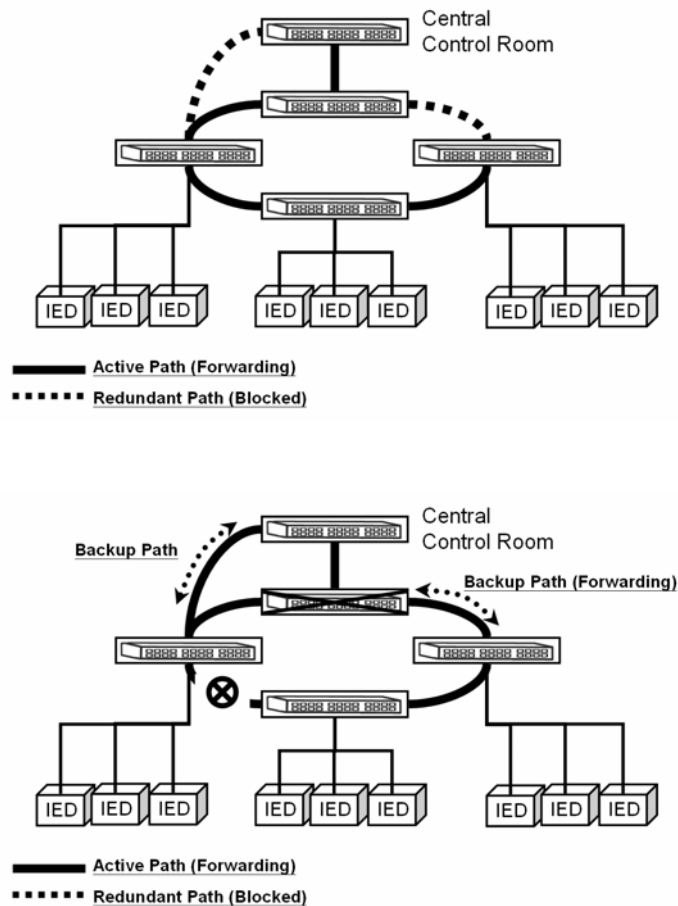

Network Management Functions

Intelligent Layer 3 Network Control

Power automation systems are built on networks of immense size, often utilizing the largest network infrastructure in a particular region or country. For large, complex infrastructures, Layer 2 switches may not be able to provide optimal performance due to the volume of network devices and data. Layer 3 switches are better suited for the very large networks used in substation automation, and can be used to split the network into several sub-networks. Network traffic can be confined to within different subnets, greatly improving overall network performance. Layer 3 switches can also provide faster, more effective data forwarding than general routers.

Moxa White Paper

VLANs with IEEE 802.1Q

For management and security reasons, it is often desirable to keep certain substation devices and functions organized or limited to within a single physical network. However, there may be physical restrictions that make it impossible to do so. With Ethernet switches that support IEEE 802.1Q, virtual LANs (VLANs) can be used to organize networks in a way that is not dictated by the physical network connections.

For example, IEDs connected to different physical networks can be allowed to communicate easily by assigning them to the same VLAN group. Devices on the same physical network can be assigned to different VLANs to prevent communication with each other, for extra security and protection. Flexibility with the network structure is an especially valuable feature for substations, since the elements of a substation automation system may be spread out over a large area.

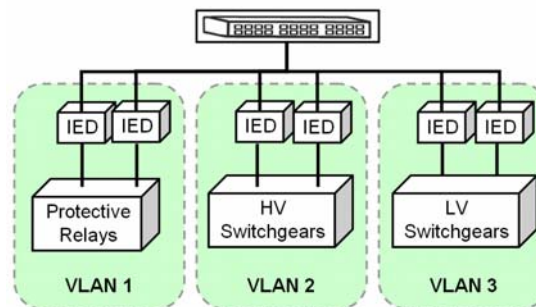

Authentication with IEEE 802.1X

Network security is a critical issue for substation automation systems. Private intranets can still be cracked by the wrong internal operation. Authentication is an efficient and effective process for substation network security. With authentication, only qualified users are able to operate the system. IEEE 802.1X (Port-Based Network Access Control) is a strong authentication standard that requires users to be authenticated against a local user database or an external RADIUS server.

Moxa White Paper

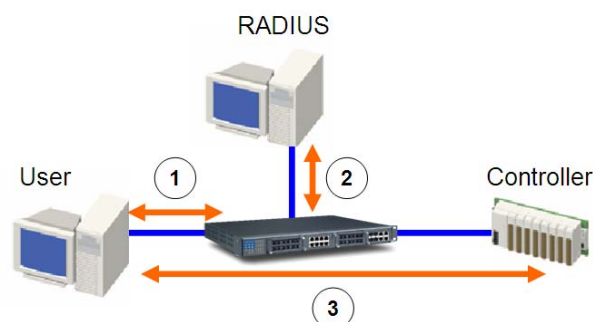

- Step 1: User begins authentication process with authenticator (Ethernet switch)
- Step 2: User information is authenticated against local user database or external RADIUS server
- Step 3: After successful authentication, user communicates with device through Ethernet switch

Quality of Service with IEEE 802.1p

As networks grow in size and complexity, it is essential that administrators have an effective way to manage the growing volume of traffic on the network backbone. Quality of Service (QoS) is an important tool for ensuring that the most critical data is delivered consistently and predictably. For substation automation systems, the most important data types are "Protection", "Metering" and "Control", with "Protection" having the highest priority.

With support for IEEE 802.1p, Ethernet switches can prioritize network traffic so that critical protection commands are always transmitted immediately. QoS functions help ensure that substation network performance is both reliable and predictable.



Moxa White Paper

IGMP for Multicast Traffic

In the course of controlling and monitoring the power grid, substations send a large amount of broadcast data to dispatch centers, secondary substations, and other control units. The high volume of broadcast traffic can cause bandwidth to suffer, potentially delaying the transmission of other, more critical network traffic. Ethernet switches that support GMRP (GARP Multicast Registration Protocol) and IGMP snooping can prune multicast traffic to optimize network performance for substation automation systems. Multicast data is only transmitted to the required destinations, rather than bogging down the network and jeopardizing critical operations.

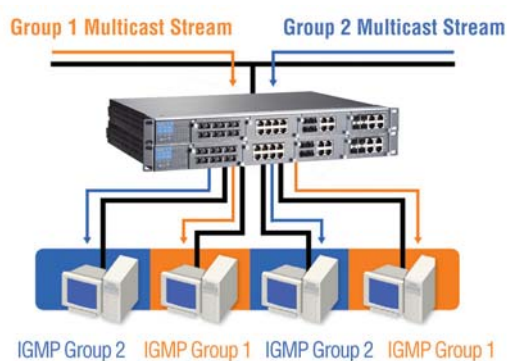

Backup Configuration

Rugged Ethernet switch design and redundant network topologies can ensure a high degree of reliability for a substation automation system. However, a contingency plan is still necessary in the event that a switch fails and needs to be replaced. A common and effective strategy is to keep replacement switches on standby.

Engineers are usually expected to manually install and configure replacement switches as needed. System downtime can be minimized by making configuration as simple as possible. Replacement switches can be configured in advance, or the configuration may be imported from a backup. User-friendly tools are also available to simplify the replacement procedure.

Moxa White Paper

Shown below is an example of a tool that makes it easy for non-technical users to copy the configuration from a faulty switch onto a new switch. The replacement switch can be automatically configured with little training and no knowledge of protocols or programming. This type of user-friendly feature can drastically reduce system downtime if an Ethernet switch fails on-site.

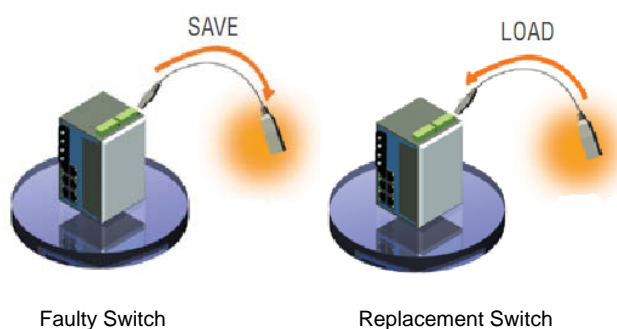

Conclusion

In industries around the world, Ethernet networks form the main communication backbone between devices, systems, and users. For substation automation systems, Ethernet networks have been deployed with great success by paying careful attention to special requirements and conditions. The guidelines presented in this white paper can assist power administrators in ensuring optimal network performance and reliability. With proper planning and the proper equipment, a robust Ethernet network can be established that maximizes a power utility's ability to deliver reliable, uninterrupted electric power to the public.

Disclaimer

This document is provided for information purposes only, and the contents hereof are subject to change without notice. This document is not warranted to be error-free, nor subject to any other warranties or conditions, whether expressed orally or implied by law, including implied warranties and conditions of merchantability, or fitness for a particular purpose. We specifically disclaim any liability with respect to this document and no contractual obligations are formed either directly or indirectly by this document. This document may not be reproduced or transmitted in any form for any purpose, without our prior written permission.